

Bob Pro

OWNER'S MANUAL



bObsweep

Bob Pro

OWNER'S MANUAL

Model SJP110020
Manual Version 2019.1



Congratulations!

Congratulations on your new intelligent floor cleaner! Bob is now at your service. To see Bob at his best, please read the Quick Start Guide and this manual thoroughly.

Welcome to the bObsweep family and Happy Sweeping!

If you have any questions or concerns, feel free to contact our helpful support team at support@bobsweep.com or 1-888-549-8847.

Our business hours are Monday – Friday, 9 a.m. – 5 p.m. Pacific Standard Time.

Important Safety Instructions

Turn Bob OFF and unplug him from the outlet when he is not in use and before conducting maintenance.

Bob is not intended for use by persons (including children) with reduced physical or mental capabilities, or lack of experience and knowledge, unless under the close supervision of a person responsible for their safety.

Leaks from the battery cells can occur under extreme usage or temperature conditions. If the liquid gets on the skin, wash quickly with water. If the liquid gets into the eyes, flush them immediately with clean water for a minimum of 10 minutes, and seek medical attention.

Bob is composed of electronic components that in rare and unintended cases can cause hazards of heating, fire, and other malfunctions. Furthermore, because Bob is capable of autonomous movement, his use poses the risk of collision with property, pets, and persons. Unintended removal of articles — such as small valuables, jewelry, or hair of persons or pets lying on the floor — may also occur.

If Bob, his remote control, charging station, or bIOck Plus™ has been damaged in any way, do not operate them. Contact our customer care center at support@bobsweep.com.

✗ Do not handle Bob, his remote control, or charging station with wet hands; use only on dry surfaces.

✗ Do not pull or carry the charging station by the cord, use the cord as a handle, close a door on the cord, or pull the cord around sharp edges or corners. Keep the cord away from heated surfaces. To unplug the cord, grasp the plug, not the cord.

✗ Do not attempt to open the charging station. Repairs on the station should only be carried out by our qualified technicians.

✗ Do not immerse any part of Bob in water or other liquids. You may immerse the dustbin in water after removing the filters.

✗ Do not mutilate or incinerate the battery, as it will explode at high temperatures.

✗ Do not use Bob outdoors.

✗ Do not expose Bob, his charging station, or remote control to temperatures higher than 113° F (45° C), moisture, or humidity.

✗ Do not dispose of your battery in fire. Old batteries should be recycled safely through your local recycler.

✗ Do not let Bob pick up anything that is burning or smoking, such as cigarettes, matches, or hot ashes.

Declaration of Conformity

This device complies with Part 15 of the FCC rules. Operation is subject to the following two conditions: (1) this device may not cause harmful interference, and (2) this device must accept any interference received, including interference that may cause undesired operation. The manufacturer is not responsible for any radio or TV interference caused by unauthorized modifications or change to this equipment. Such modifications or change could void the user's authority to operate the equipment.

This equipment has been tested and found to comply with the limits for a Class B digital device, pursuant to part 15 of the FCC Rules. These limits are designed to provide reasonable protection against harmful interference in a residential installation. This equipment generates, uses, and can radiate radio frequency energy and, if not installed and used in accordance with the instructions, may cause harmful interference to radio communications. However, there is no guarantee that interference will not occur in a particular installation. If this equipment does cause harmful interference to radio or television reception, which can be determined by turning the equipment off and on, the user is encouraged to try to correct the interference by one or more of the following measures:

- Reorient or relocate the receiving antenna.
- Increase the separation between the equipment and receiver.
- Connect the equipment to an outlet on a circuit different from that to which the receiver is connected.
- Consult the dealer or an experienced radio/TV technician for help.

Warranty

Every Bob Pro purchased from an authorized seller includes a 1-year limited warranty, 5-year subsidized repair plan, and lifetime of customer support. The warranty covers the battery, labor, and non-consumable parts; it does not cover postal charges and consumable parts such as brushes and filters.

Even after Bob's 1-year warranty is over, replacement parts and visits to the bObsweep hospital are subsidized between 25% – 50% for 5 years from the date he was first purchased.

To activate Bob's warranty, register him online at www.bobsweep.com/warranties. To purchase additional coverage plans, go to www.bobsweep.com/coverageplan.

Table of Contents

04 Getting Started

- 6. Box Contents
- 8. Bob's Anatomy
- 10. Get to Know Bob
- 12. Get Bob Started

16 Charging

- 18. Charging Station
- 20. Charging Bob

22 Remote Control

- 24. Remote Buttons
- 26. Syncing the Remote
- 28. Navigating Bob

30 Cleaning Schedule

- 32. Setting Current Time
- 34. Setting Cleaning Schedule

36 Parts and Maintenance

- 38. Dustbin
- 42. Filters
- 44. Main Brush
- 46. Side Brush
- 48. Battery
- 50. Sensors
- 52. Wheels

54 Troubleshooting

- 56. Left Wheel
- 58. Right Wheel
- 60. Wheel Sensors
- 62. Front Wheel
- 64. Edge Sensors
- 66. Low Battery
- 68. Touch Sensors
- 70. Main Brush
- 72. Side Brush
- 74. Wall Sensors
- 76. Vacuum Motor
- 78. Power System

80 End User License Agreement

Getting Started

Let's start at the very beginning. We'll walk you through the basics and help you get Bob started for the very first time.

- 6 Box Contents
- 8 Bob's Anatomy
- 10 Get to Know Bob
- 12 Get Bob Started



Box Contents

Bob comes with the following items. You can purchase replacement parts and accessories at www.bobsweep.com/shop.

1 Charging Station

2 Charging Adapter

3 Remote Control

4 Spare Filters

5 Cleaning Tool

6 Side Brush Screws (2)

7 Phillips Head Screwdriver

8 Spare Side Brushes (2)

9 Owner's Manual, Quick Start Guide,
and Warranty Card

10 Bob Pro

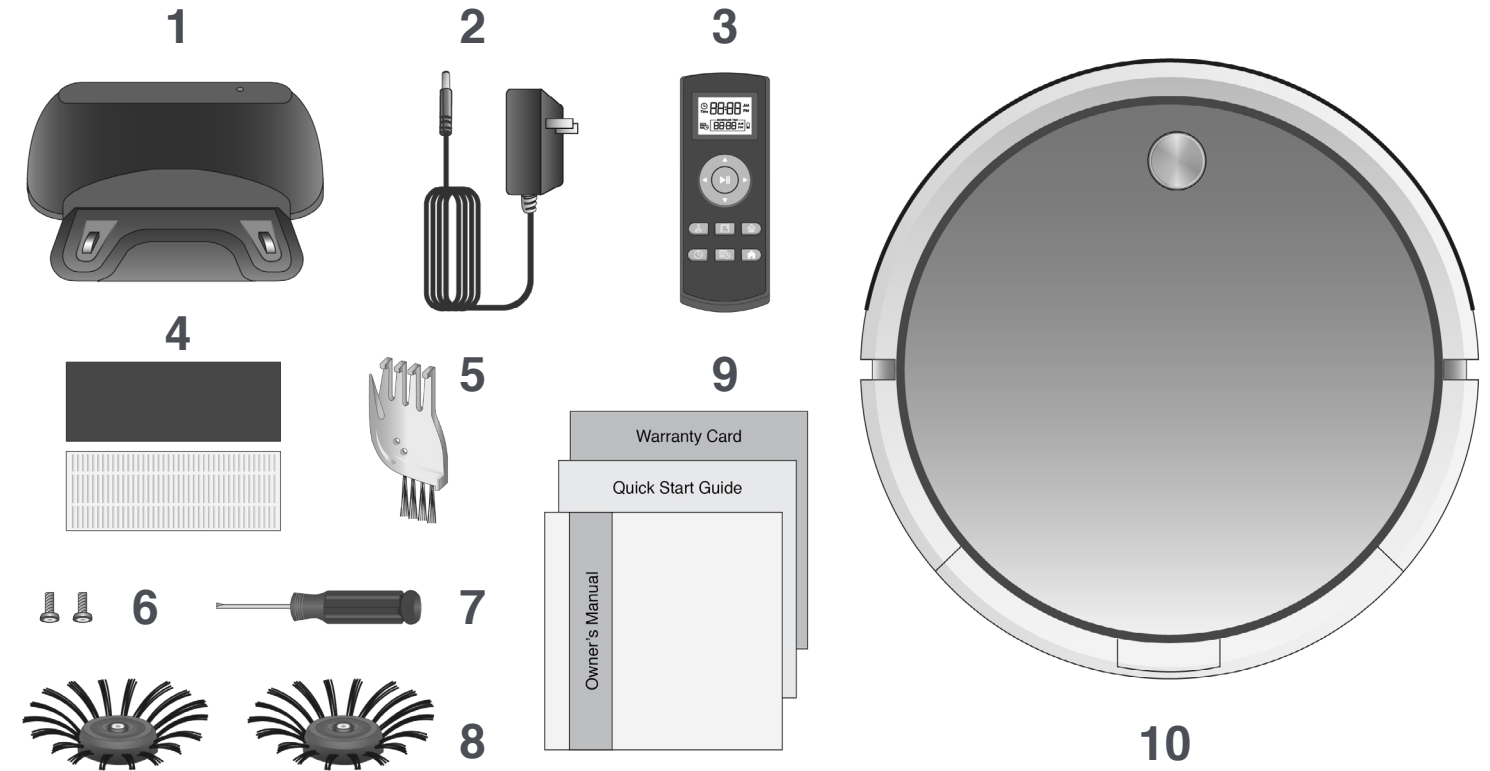

Bob's Anatomy

Top View

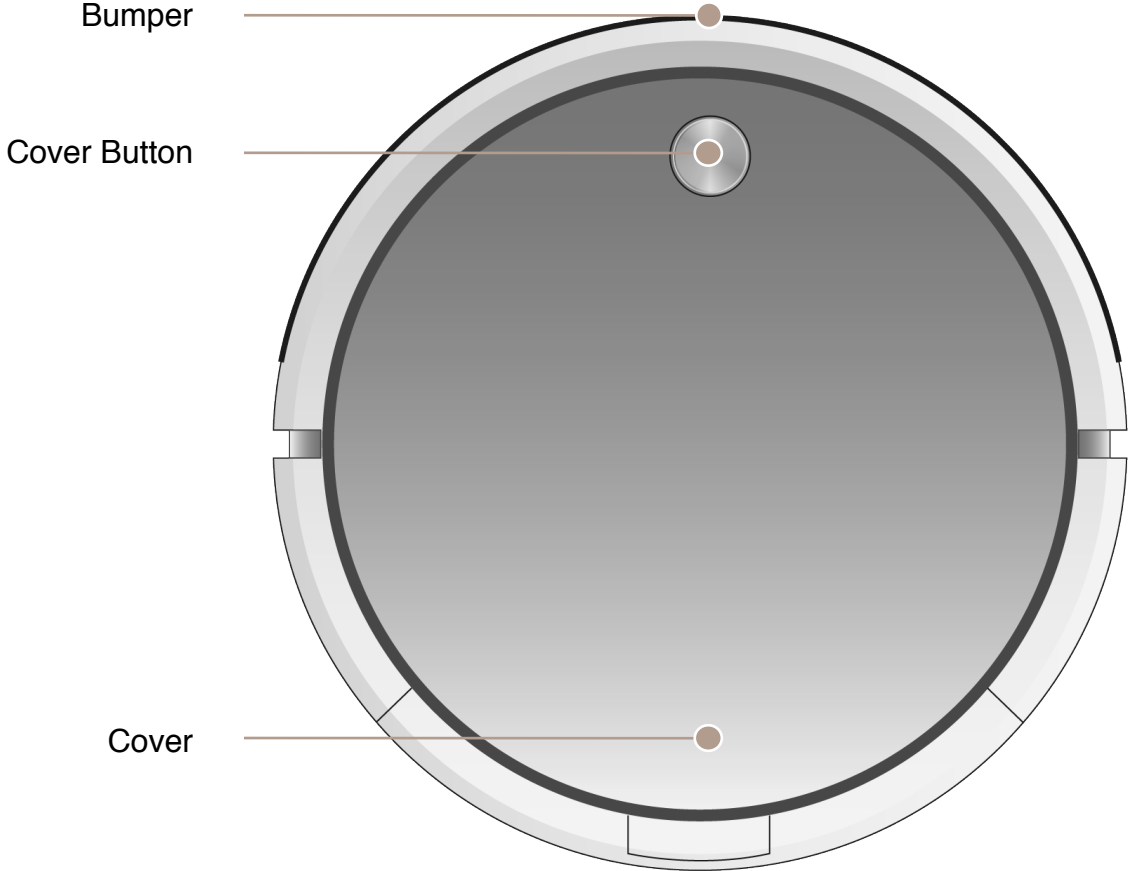

Bottom View

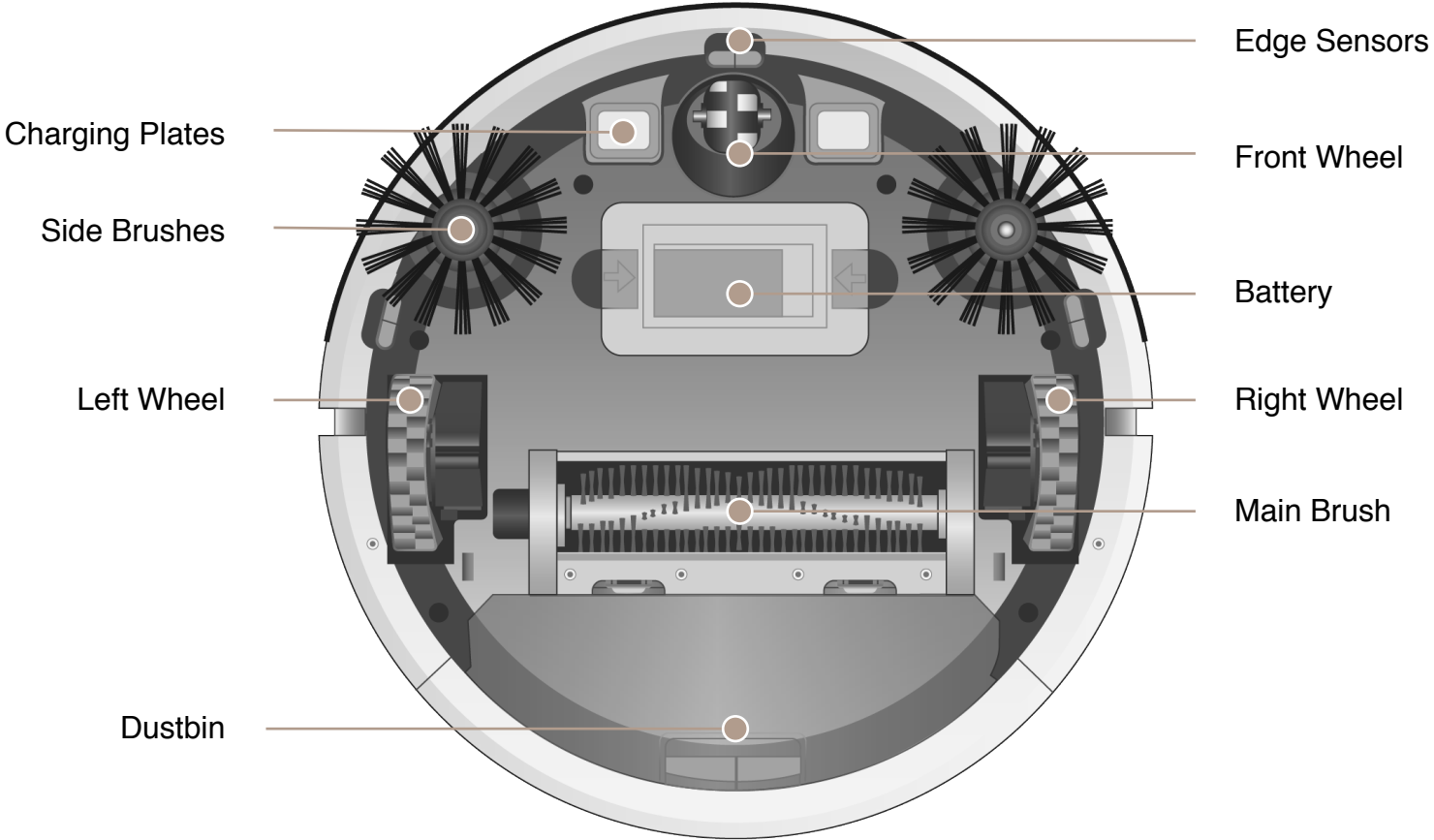

Who is Bob?

Bob is an autonomous robotic vacuum cleaner, at your service! He can vacuum and sweep all the same time — and at the end of his cleaning session, he automatically returns to his station for a power nap. Set Bob to clean on a schedule and he'll clean on his own even when you're not around.

Should I pick up Bob?

You may pick up Bob while he's cleaning, but it's best to let him work in his own way. Moving him around, manipulating his movements, or picking him up may confuse him and disrupt his cycle.

How does Bob find his way around?

Bob doesn't store any data about your home; instead, he uses a network of reactionary sensors to detect obstacles. To maximize his coverage, he may spiral outward, zigzag across a small area, or follow along walls. If he seems to be ignoring some spaces or spending too much time on others, don't worry! Bob will efficiently clean your home over the course of a full cycle — just check his dustbin for the evidence!

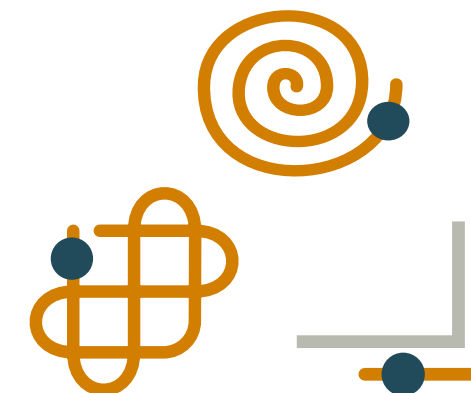

Navigating Difficult Obstacles

Unique Furniture

Bob is designed to maneuver around furniture of most shapes and sizes, but he may find it difficult to clean under chairs with narrow legs or furniture that is too high for his bumper sensors to detect. Specialty furniture, such as desk chairs with wheels or stools with circular bases, may also confuse him momentarily — but don't worry, Bob usually finds his way around with time.

Dark-Colored Carpet

Bob may have difficulty cleaning dark carpet due to his infrared edge sensors. Bob will repeatedly back up or stop working when his edge sensors are being triggered. Keep Bob away from dark carpet that interferes with his edge sensors.

Shag Carpet

Bob's main brush is not designed to clean shag carpet or rugs with long fibers. If you'd like Bob to clean shag carpet or long-fibered rugs, you may remove his main brush and allow him to vacuum without it.

Inclines

Sometimes Bob will attempt to drive up angled surfaces, get stuck for a few minutes, and then decide to clean somewhere else. As long as Bob does not display a trouble message on his screen, let him continue cleaning and find his own way around. Take note of the areas Bob finds the most challenging and, if possible, adjust your furniture accordingly.

Step 1: Charge Bob

Allow Bob to fully charge before using him for the first time.

Parts You'll Need:

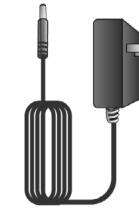

Power Adapter



Charging Station

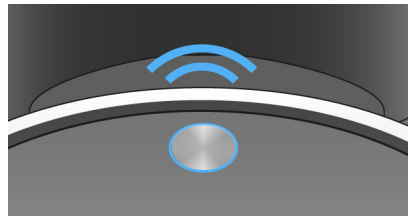

Bob will chirp once and slowly blink his cover button to let you know that he is charging.

When Bob has fully charged, his cover button will stop blinking and remain solid.

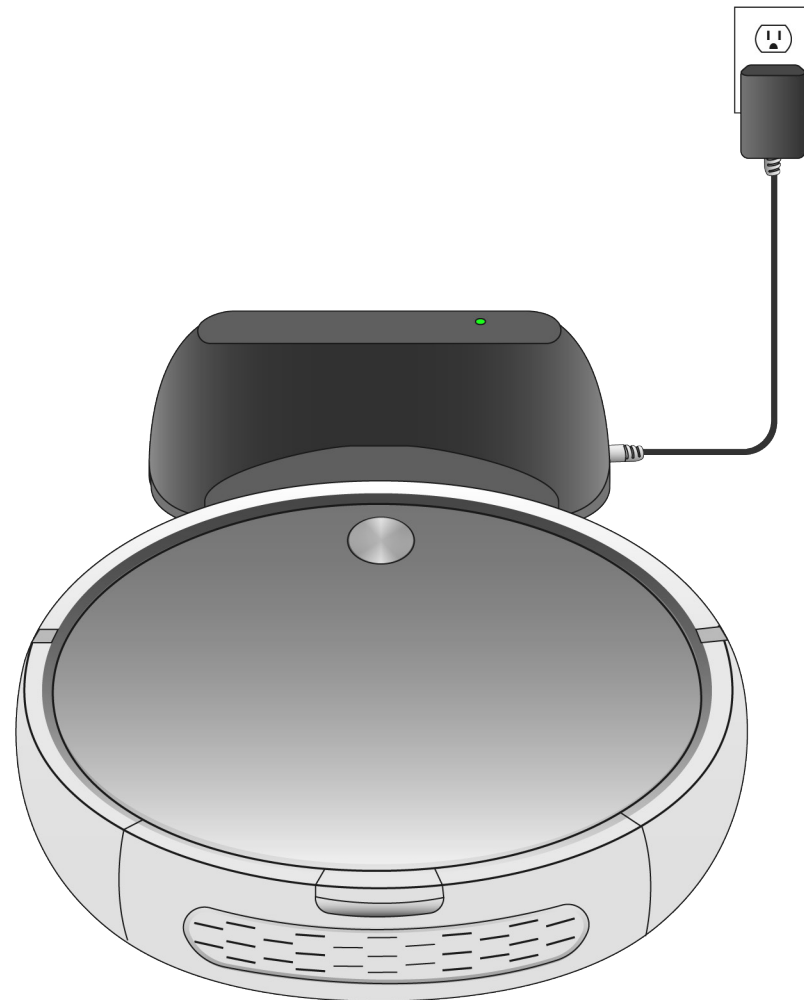

1. Plug the power adapter into the side of the charging station. The station's green power light will turn on.

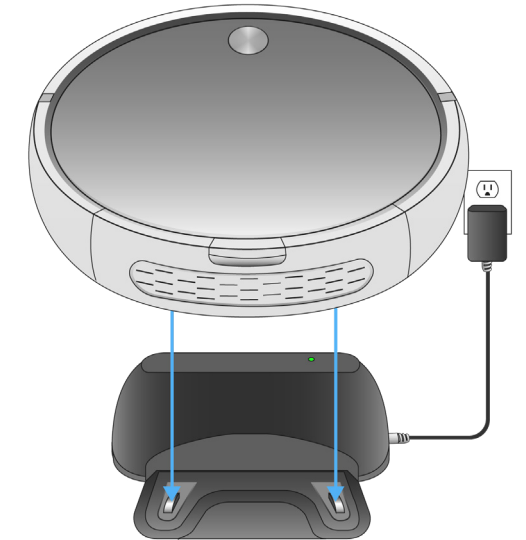

2. Place Bob on his charging station with the metal plates on his underside sitting on top of the nodes on his station.

Quick Tip:

- The green light on the station will be turned off while Bob is charging.

Step 2: Click and Go!

Once Bob is fully charged, he is ready to clean!

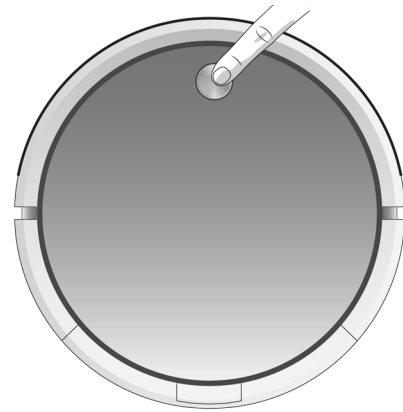

OR

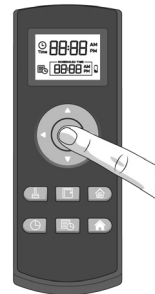

Press Bob's cover button, or the ►|| button on his remote, and he will clean on his default Robot mode.



Quick Tip:

If Bob is left idling for 5 minutes, he will enter standby mode to conserve his battery. When in standby mode, Bob is paused.

To take him out of standby mode, press his cover button or any button on his remote.

Bob works on the 2-Click System!

1 click to clean, and 2 clicks to charge.
It's as easy as 1-2-Sweep.



Charging

Bob automatically returns to his charging station when low on battery. To maximize Bob's chance of finding his station, it's best to place it in an easily accessible location with plenty of space around it.

18 Charging Station

20 Charging Bob



Charging Station

Bob will automatically return to his charging station when low on battery. To maximize Bob's chance of finding his station, place it in an easily accessible location with plenty of space around it.

Parts You'll Need:



Power Adapter



Charging Station

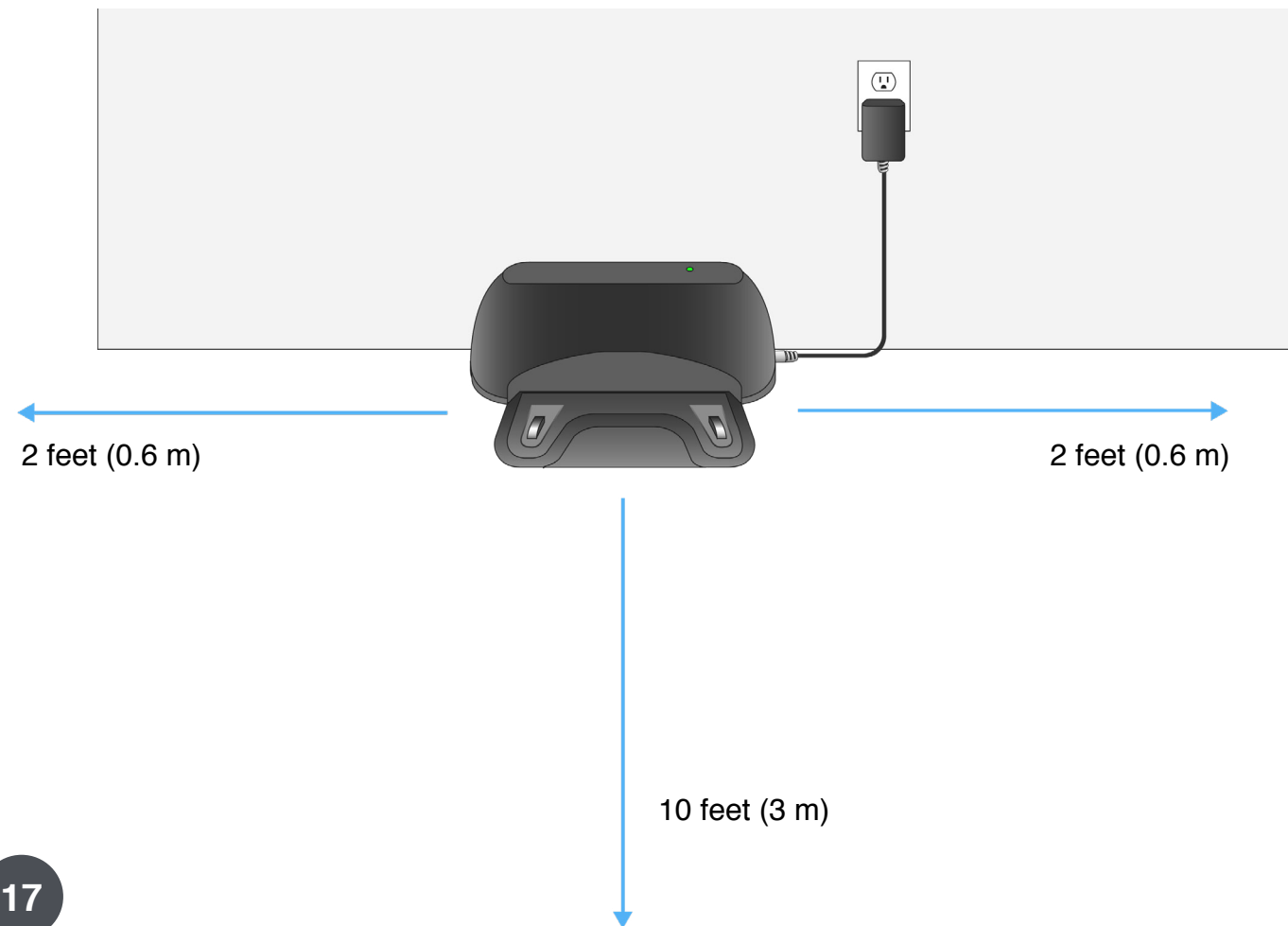

1. Position the charging station against a wall on a hard, flat surface. If possible, avoid positioning the charging station on carpet or soft surfaces.

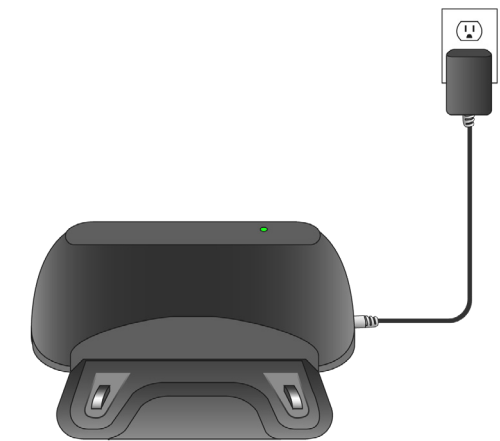

2. Make sure there is at least 10 feet (3 m) of open space to the front and 2 feet (0.6 m) of open space to the sides of the station.

Quick Tip:

✗ Do not move Bob's charging station while he is working.

Charging Bob

Bob will automatically return to his charging station when low on battery. You can send Bob to charge at any time by double clicking his cover button or pressing the 🏠 button on his remote.

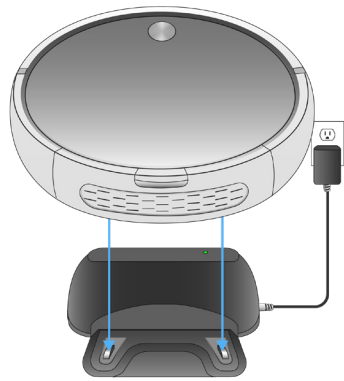

Charging Bob on the Charging Station

To charge Bob, place him on his charging station with the metal plates on his underside sitting on top of the nodes on his station. Make sure the station is plugged in.

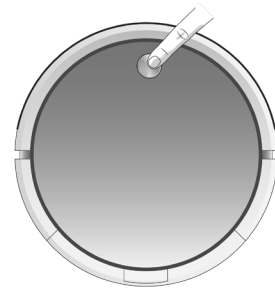

Sending Bob to Charge

To send Bob to his charging station, double click his cover button or press the 🏠 button on his remote.

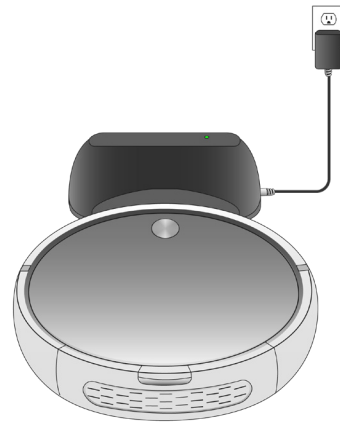

Conserving Bob's Battery

Bob should not sit on his charging station for more than 5 days. If you will not be using him at least once every 5 days, turn him off and remove him from the station to conserve his battery.



To turn Bob off, push in the bumper while pressing the cover button for about 4 seconds. Release the button when you hear Bob chirp. Bob's cover light will then turn off.



Bob will chirp once and slowly blink his cover button to let you know that he is charging.

When Bob has fully charged, his cover button will stop blinking and remain solid.

Remote Control

You can set Bob's cleaning schedule, select his cleaning modes, and control his movements all from his remote control.

- 24 Remote Buttons
- 26 Syncing the Remote
- 28 Navigating Bob



Remote Buttons

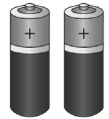

Bob's FullCommand™ remote requires 2 AAA batteries (not included). Remove the batteries if you are not using the remote on a regular basis. Keep the remote at room temperature.

- | | |
|---|--|
| 1 <u>Start / Stop</u>
Starts or pauses Bob's movements. | 5 <u>Set Current Time</u>
Sets the current time. |
| 2 <u>Navigational Butons</u>
Guide Bob forward, backward, right, or left. | 6 <u>Set Cleaning Schedule</u>
Sets Bob's cleaning schedule. |
| 3 <u>Auto</u>
Puts Bob on his default setting (Robot mode). | 7 <u>Quick Clean (30 min)</u>
Sends Bob to clean for 30 minutes. |
| 4 <u>Wall Track™</u>
Sends Bob to clean along walls and corners. | 8 <u>Charge</u>
Sends Bob to his charging station. |

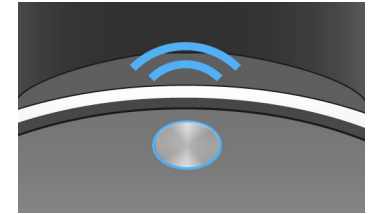
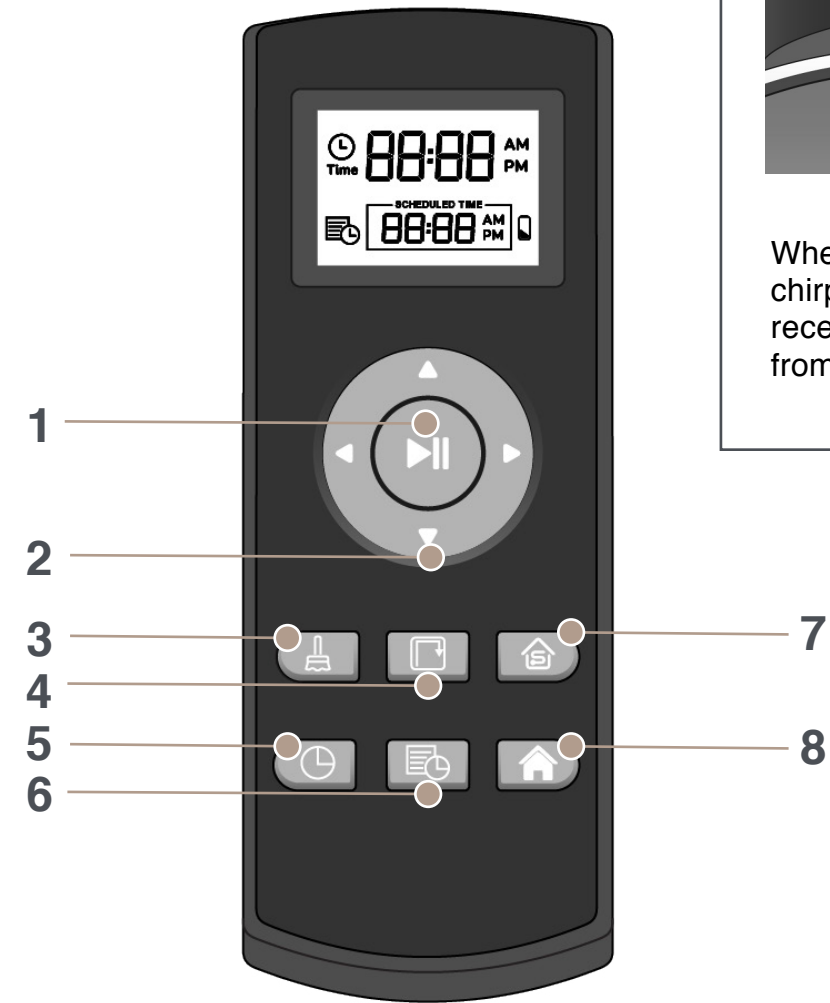

When Bob is on, he chirps every time he receives a command from his remote control.

Syncing the Remote

If Bob is not responding to his remote, he may need to be synced to it. You will only need to do this once. Make sure the remote has a working pair of batteries before proceeding.

Parts You'll Need:



Remote Control



AAA Batteries x2
(not included)

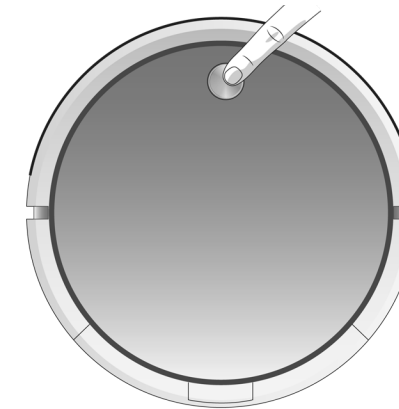

1. While still holding down the ►|| button, press and hold Bob's cover button for 4 seconds.

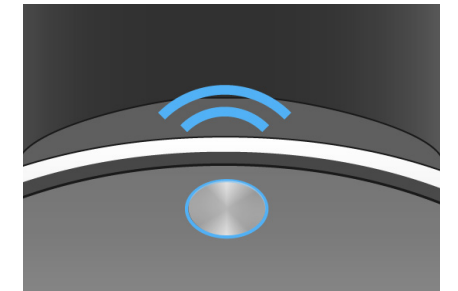

Bob will chirp 3 times to let you know the sync was successful.

Navigating Bob

Hold down the navigational buttons to control Bob's movements.

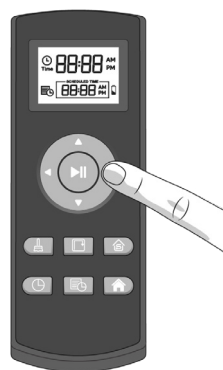

1. Hold down a navigational button on the remote to keep Bob moving in the desired direction.

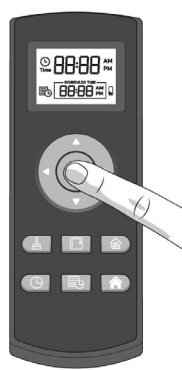

2. Press the ►|| button to return Bob to his default Robot mode.

Important to Note:

 Bob can be manually controlled only while he is in his default Robot mode, not while he is in Quick Clean or Wall Follow modes.

Using the navigational buttons resets Bob's cleaning algorithm, so it is not recommended that you repeatedly control Bob while he is cleaning. It is best give Bob some time to understand your home so he can clean at his best.

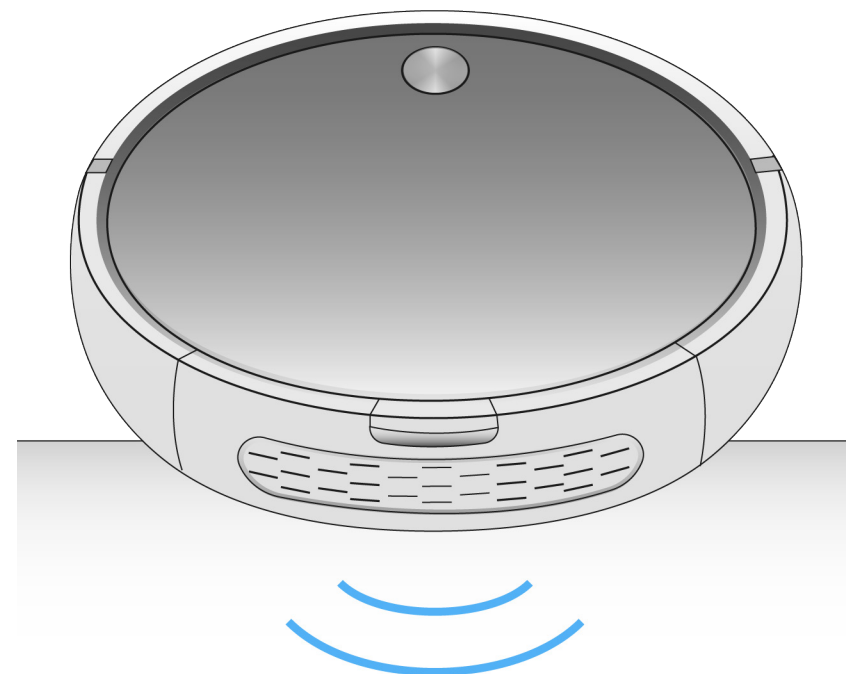

Quick Tip:

 Bob's edge sensors are located along his front, not along his back. Do not reverse Bob towards edges, as he will fall.

Cleaning Schedule

Bob can be programmed to clean every day at the time of your choice through his remote control.

- 32** Setting the Current Time
- 34** Setting the Cleaning Schedule



Setting the Current Time

Bob can be programmed to clean every day at the time of your choice through his remote control. To set Bob's cleaning schedule, you must first set the current time on his remote. Make sure the remote is synced and has a working pair of batteries before proceeding.

Parts You'll Need:



Remote Control







AAA Batteries x2
(not included)



1. Press the  button on the remote. The hour digits will start flashing.



2. Use the the  and  buttons to move between minutes and hours. Use the  and  buttons to adjust your selection.



3. Press the  button again to save your settings. Bob will chirp to confirm your save.

Setting the Cleaning Schedule

After setting the time on Bob's remote, you may set his cleaning schedule.

Parts You'll Need:



Remote Control







AAA Batteries x2
(not included)



1. Press the  button on the remote. The hour digits will start flashing.



2. Use the the  and  buttons to move between minutes and hours. Use the  and  buttons to adjust your selection.



3. Press the  button again to save your settings. Bob will chirp to confirm your save.



Parts and Maintenance

To maximize Bob's efficiency, it is best to clean his dustbin, filters, brushes, sensors, and wheels about once a week. Bob's battery should last several years and comes with a 2-year warranty.

- 38 Dustbin
- 42 Filters
- 44 Main Brush
- 46 Side Brush
- 48 Battery
- 50 Sensors
- 52 Wheels



Dustbin

To maximize Bob's efficiency, it is best to empty his dustbin about once a week, or about once every 6 cleaning cycles.



Parts You'll Need:



Cleaning Tool

Emptying Bob's Dustbin

Quick Tips:

-  Do not wash the dustbin without removing the filters first.
-  Do not force the dustbin past its natural opening point.

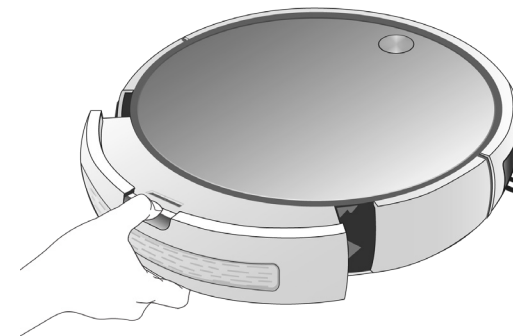
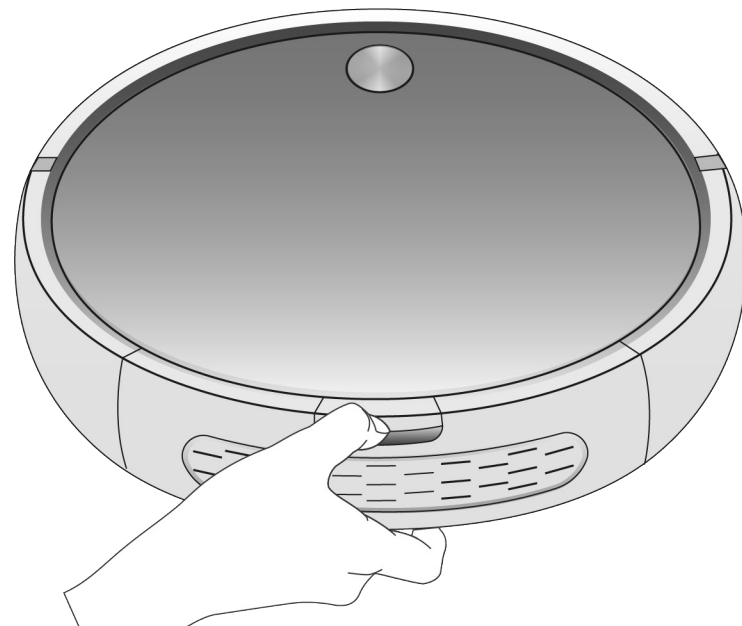

1. Push down the tab on Bob's back and slide the dustbin out.

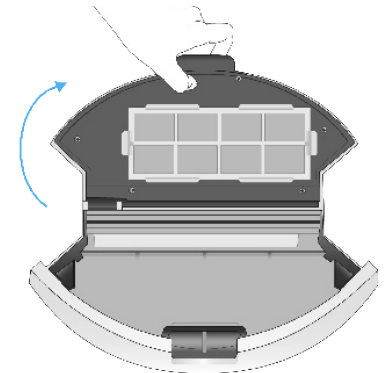

2. Lift the tab to open the dustbin.

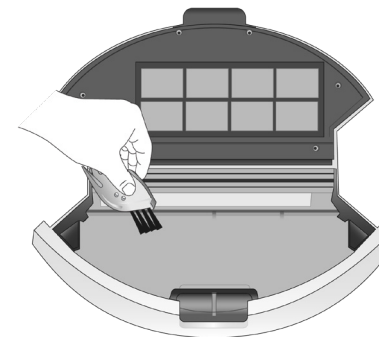

3. Dump the contents of the dustbin and brush it with Bob's cleaning tool.

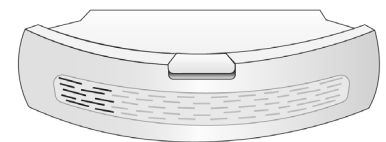

4. Close the dustbin and slide it back into Bob.

Dustbin

Bob's dustbin can be washed once you remove his filters.

Washing Bob's Dustbin

Quick Tips:

 Do not force the dustbin past its natural opening point.

 When replacing the filters, make sure the tab on the high-efficiency filter faces up.

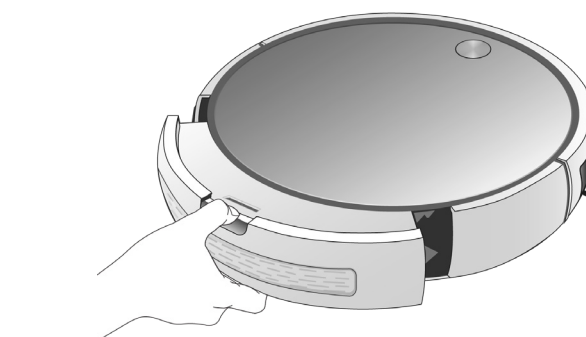
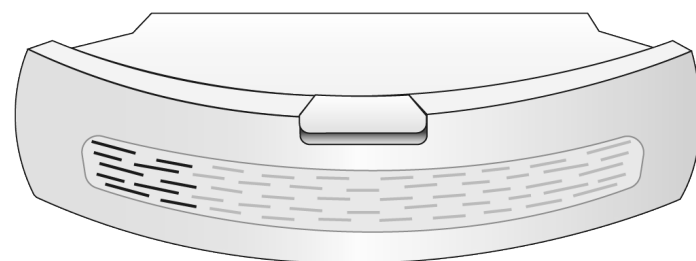

1. Push down the tab on Bob's back and slide the dustbin out.

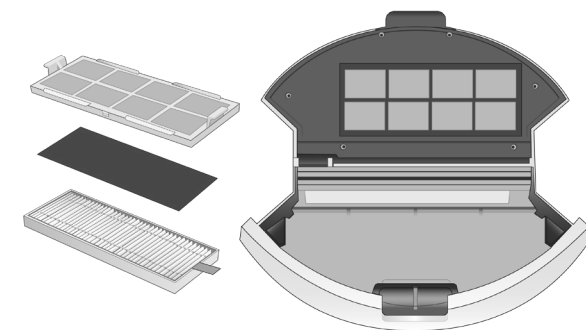

3. Remove the filters and set them aside. Wash the dustbin with water.

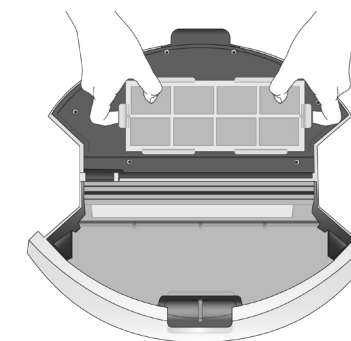

2. Lift the tab to open the dustbin. Lift the filter tray out, using the tabs for leverage.

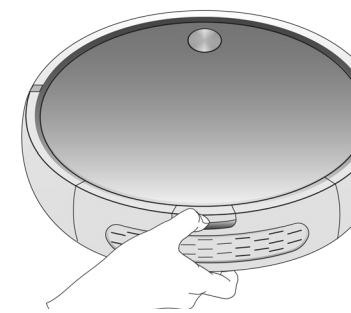

4. Allow the dustbin to fully dry before replacing the filters and filter tray. Close the dustbin and slide it back into Bob.

Filters

To maximize Bob's efficiency, it is best to clean his filters about once a week and replace them about once every 6 months. Three filters are located inside the dustbin. These filters capture fine particles and prevent them from escaping the dustbin.

Parts You'll Need:



Cleaning Tool

Cleaning Bob's Filters

Quick Tips:



Do not wash the dustbin without removing the filters first.



When replacing the filters, make sure the tab on the high-efficiency filter faces up.

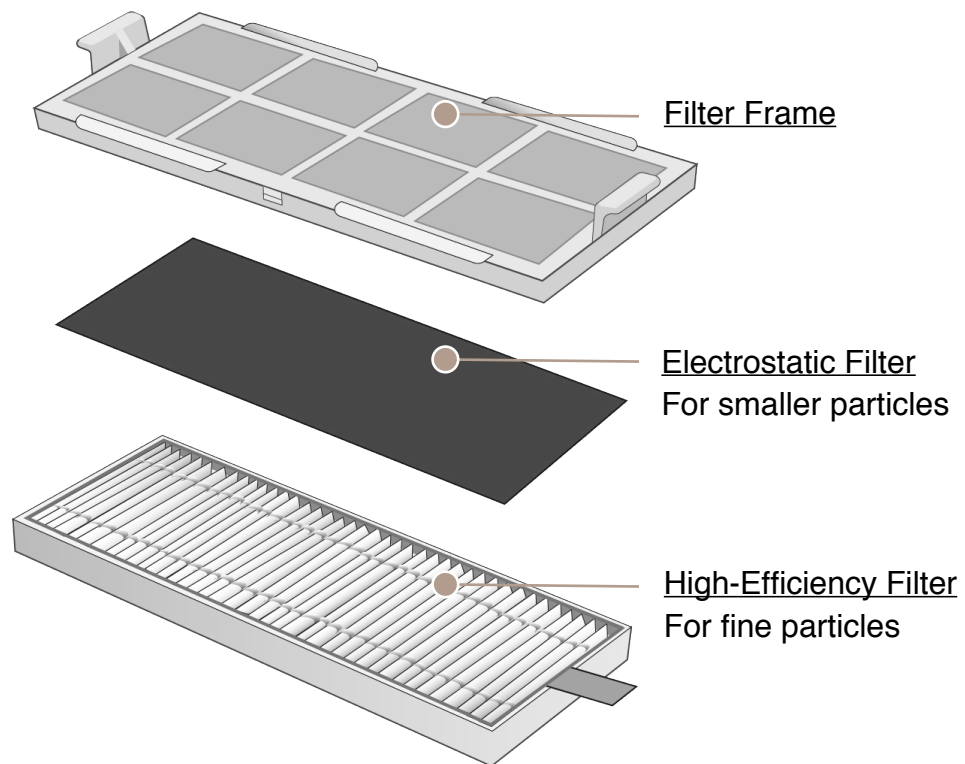

41

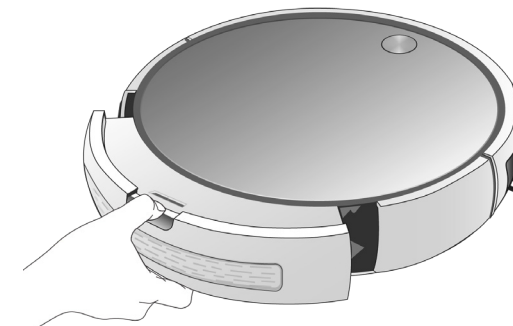

1. Push down the tab on Bob's back and slide the dustbin out.

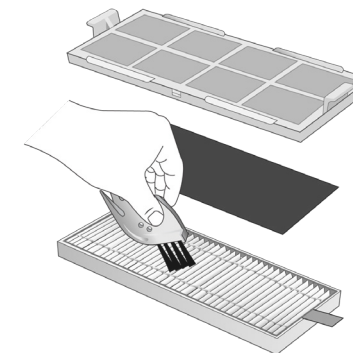

3. Remove the filters and brush them with Bob's cleaning tool.

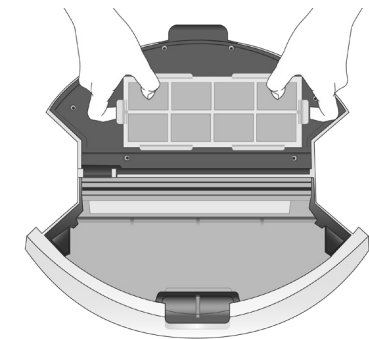

2. Lift the tab to open the dustbin. Lift the filter tray out, using the tabs for leverage.

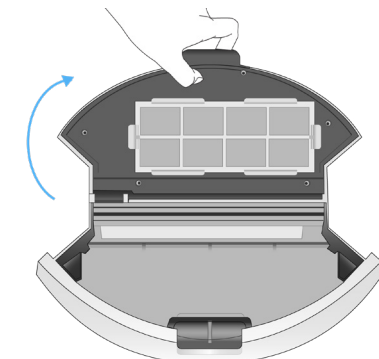

4. Replace the filters and the filter tray. Close the dustbin and slide it back into Bob.

42

Main Brush

To maximize Bob's efficiency, it is best to clean his main brush about once a week.

Parts You'll Need:



Cleaning Tool

Cleaning Bob's Main Brush

Quick Tips:



You may use scissors to cut away entanglements of hair, or tweezers to unclog the notches inside Bob.

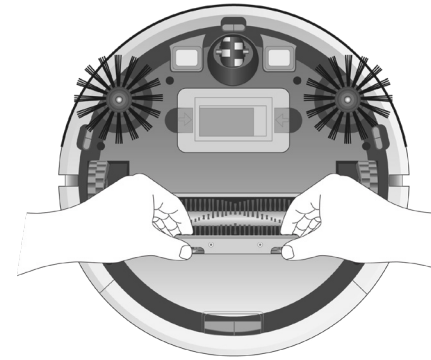
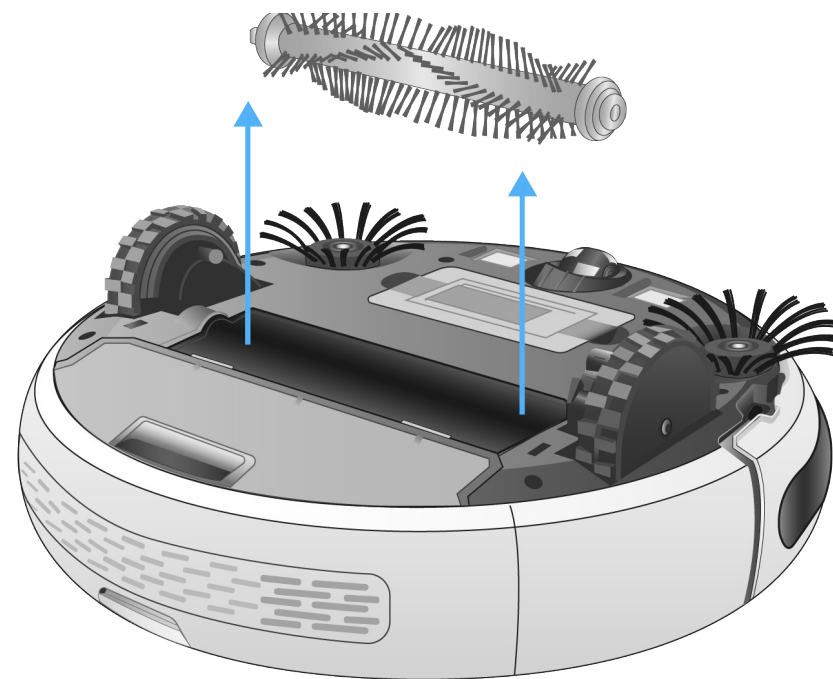

1. Push in the tabs on the main brush frame and lift.

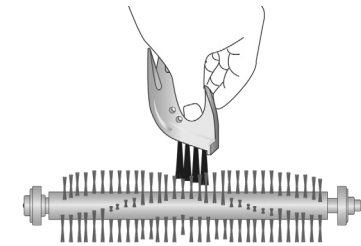

2. Use Bob's cleaning tool to clean the main brush and the notches inside Bob where the brush is held.

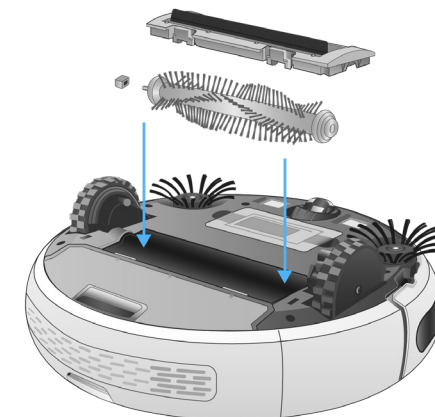

3. When done, secure the brush cap to the pin end of the main brush. Lastly, replace the main brush and main brush frame.

Side Brush

To maximize Bob's efficiency, it is best to clean his side brush about once a week.

Parts You'll Need:



Screwdriver



Cleaning Tool

Cleaning Bob's Side Brush

Quick Tips:



You may use scissors to cut away entanglements of hair, or tweezers to unclog the brush sockets.

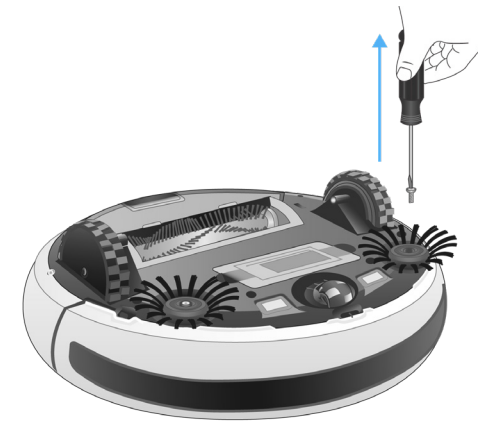
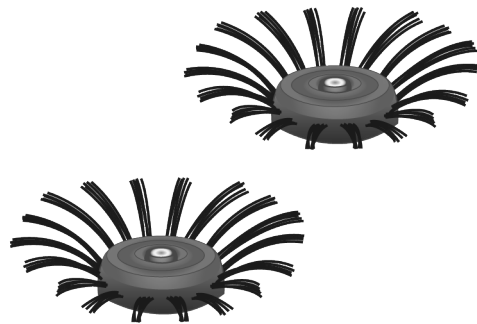

1. Remove the screw on the side brush.

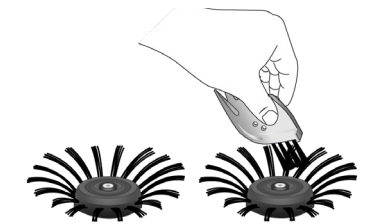

2. Use the cleaning tool to clean the side brushes and the brush sockets.



3. When done, replace the side brushes and screws.

Battery

Bob's battery has a 2-year warranty. Replacement batteries can be purchased at bobsweep.com/shop.

Replacing Bob's Battery

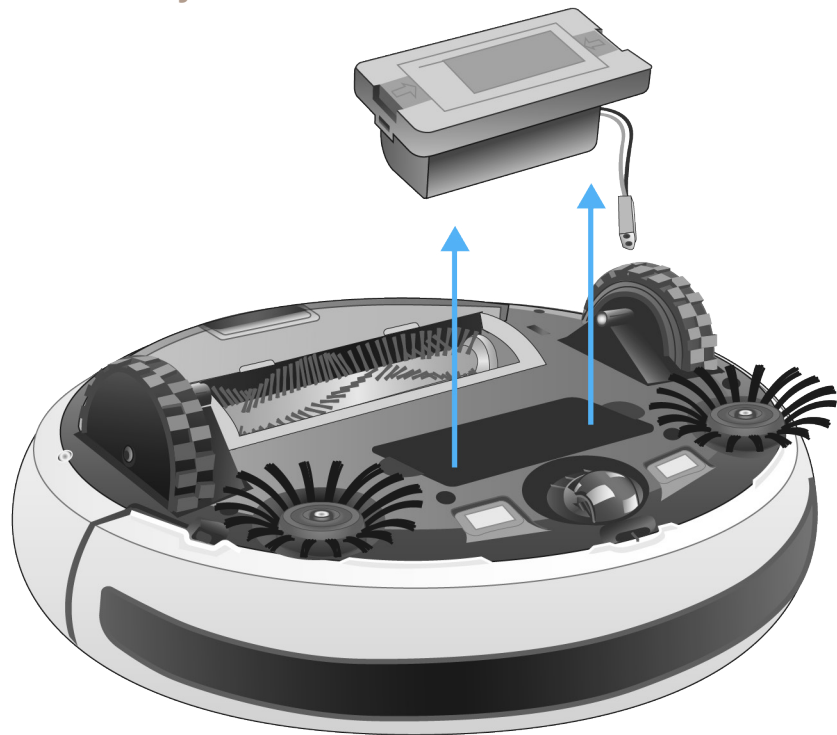

47

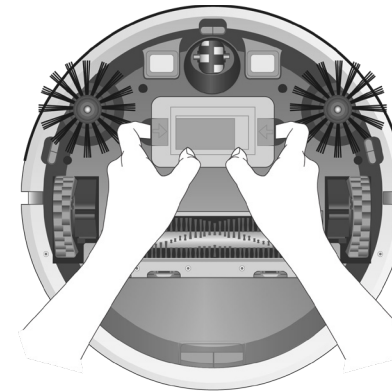

1. Pinch the orange tabs on the battery inward and lift the battery out.

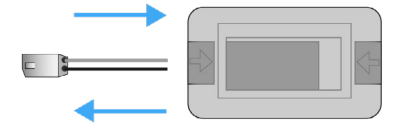

2. Unplug the old battery by pulling at the circuit junction. Then, plug in your new battery.

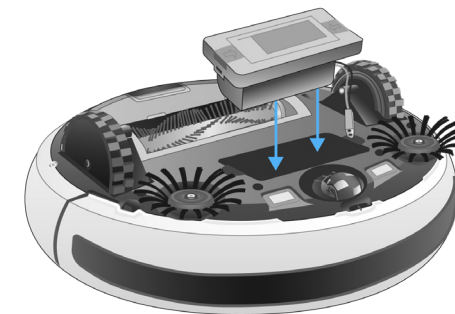

3. Slide the new battery into Bob and apply pressure until it clicks into place.

If you are not using Bob for an extended period of time, unplug his charging station, remove his battery, and store everything in a dry place at room temperature.

Do not leave Bob in direct sunlight.

48

Sensors

To maximize Bob's efficiency, it is best to clean his sensors about once a week. Bob's wall sensors are located along his bumper; his edge sensors are located along the front of his underside.

Parts You'll Need:



Cloth
(not included)

Cleaning Bob's Sensors

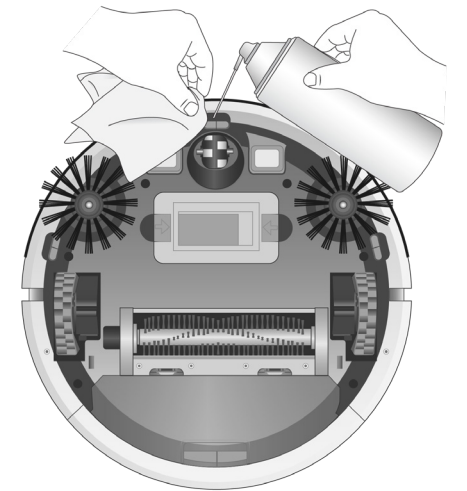
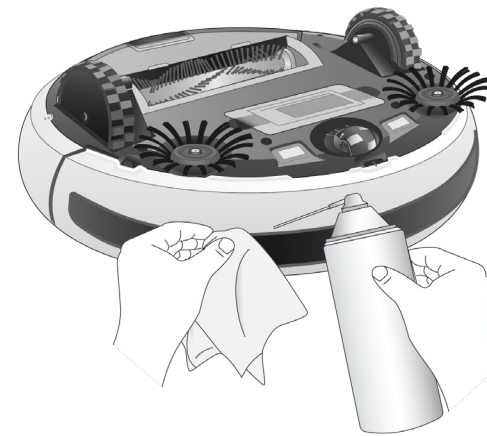
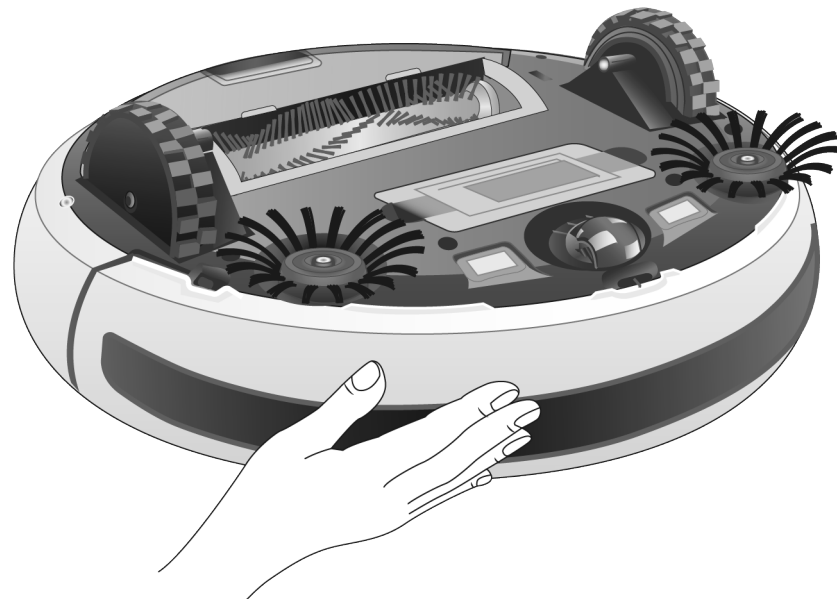

1. Wipe the wall and edge sensors using a soft cloth slightly dampened with cold water or alcohol.

Wheels

To maximize Bob's efficiency, it is best to clean his wheels about once a week.

Parts You'll Need:

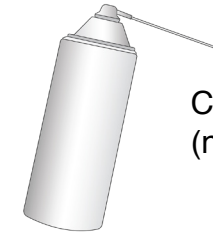

Compressed Air
(not included)



Cleaning Tool

Cleaning Bob's Wheels

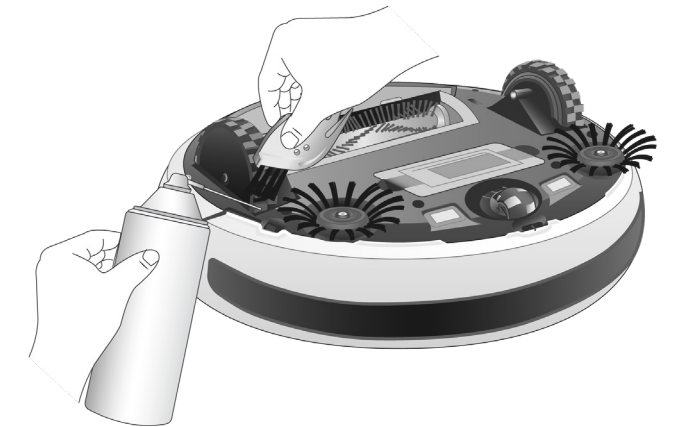
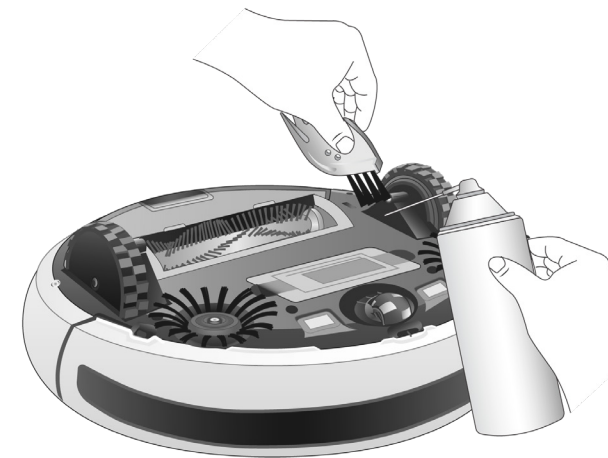

1. Clean the left or right wheels using compressed air or the cleaning tool.

Troubleshooting

When Bob encounters an issue, he communicates it through a series of red light flashes. He will beep once, flash a set number of times, pause, and then beep again before restarting the cycle.

56	Left Wheel	68	Touch Sensors
58	Right Wheel	70	Main Brush
60	Wheel Sensors	72	Side Brush
62	Front Wheel	74	Wall Sensors
64	Edge Sensors	76	Vacuum Motor
66	Low Battery	78	Power System

If Bob's problems persist, please contact our customer care center at [1-888-549-8847](tel:1-888-549-8847) or support@bobsweep.com. Our hours are Monday – Friday, 9 a.m. – 5 p.m. Pacific Standard Time.



2 Red Light Flashes: Left Wheel

If Bob stops working and flashes a red light 2 times between beeps, then his left wheel may be congested.

Parts You'll Need:

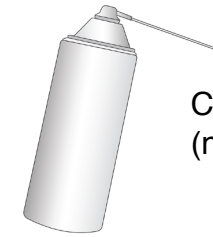

Compressed Air
(not included)



Cleaning Tool

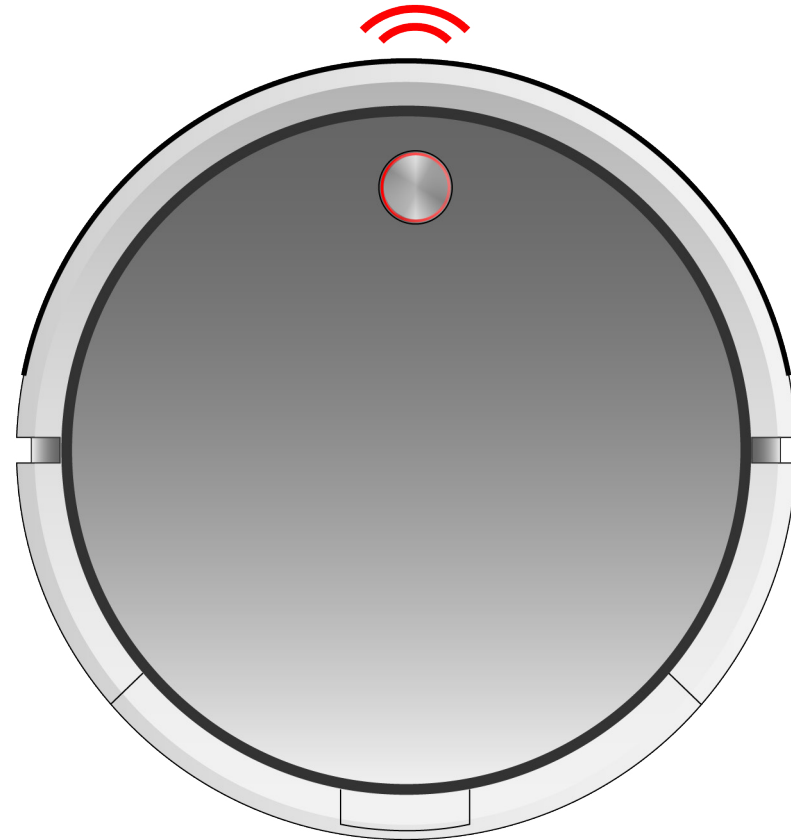

What to do:

Clean the left wheel using compressed air or the cleaning tool.

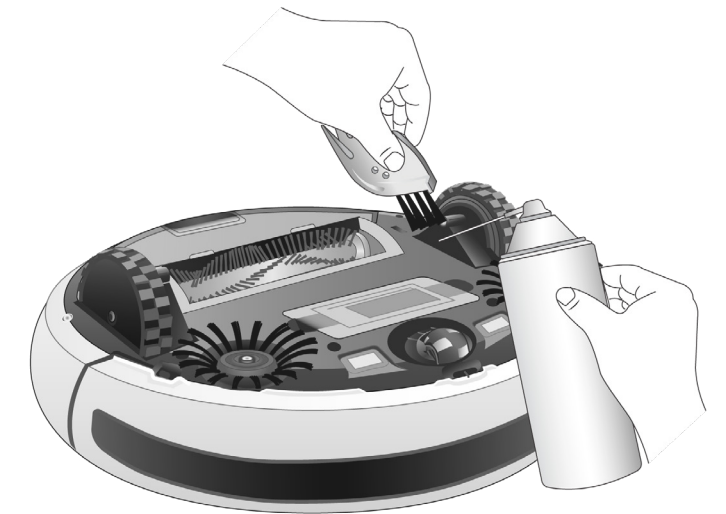

3 Red Light Flashes: Right Wheel

If Bob stops working and flashes a red light 3 times between beeps, then his right wheel may be congested.

Parts You'll Need:

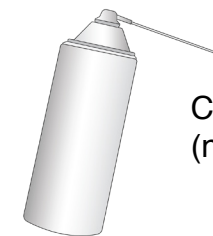

Compressed Air
(not included)



Cleaning Tool

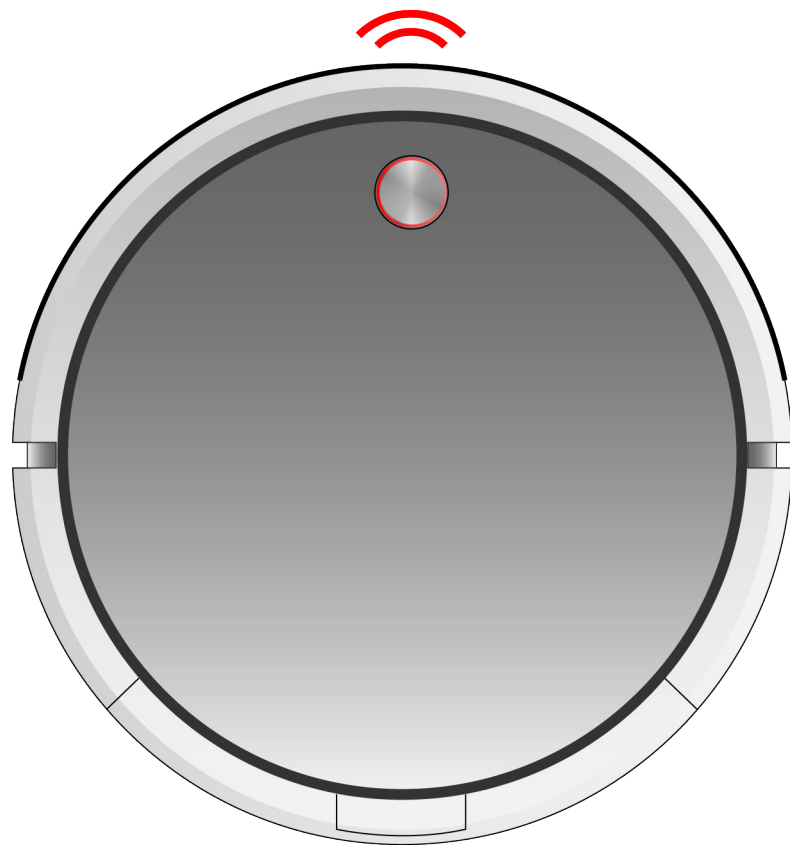

What to do:

Clean the right wheel using compressed air or the cleaning tool.

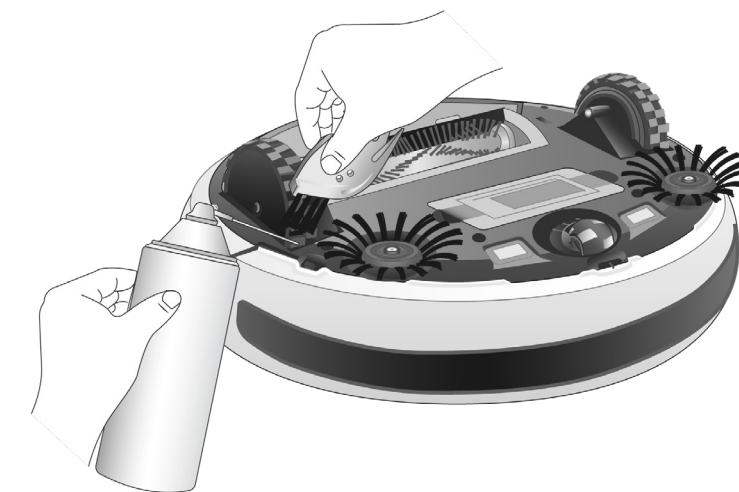

4 Red Light Flashes: Wheel Sensors

If Bob stops working and flashes a red light 4 times between beeps, then his wheel sensors may be off the floor

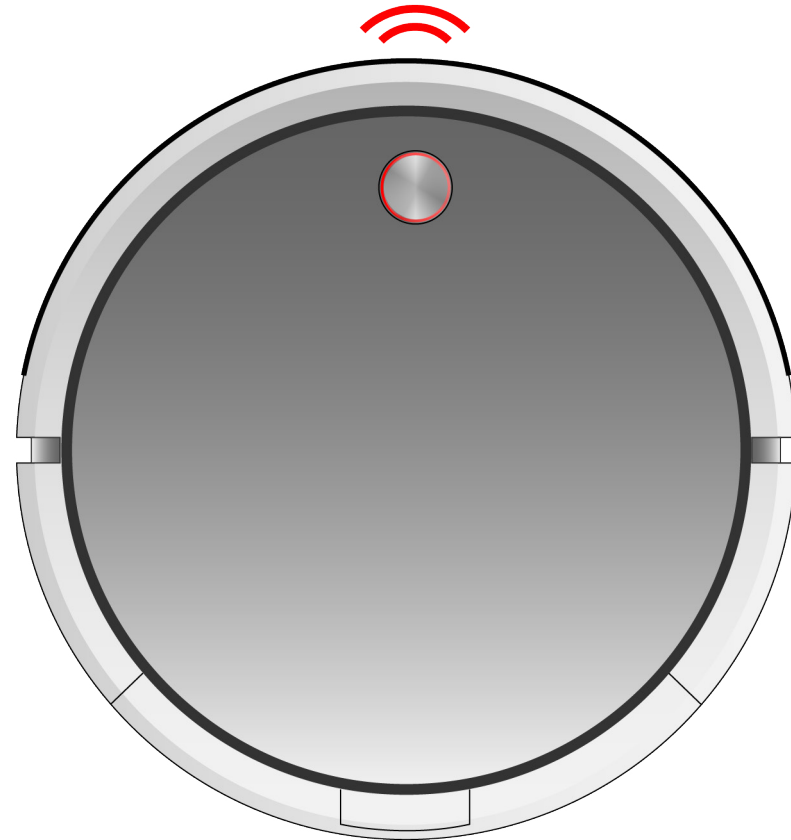

What to do:

Make sure Bob's wheels are not suspended in the air and can reach the floor evenly.



5 Red Light Flashes: Front Wheel

If Bob stops working and flashes a red light 5 times between beeps, then his front wheel may be congested.

Parts You'll Need:



Cleaning Tool

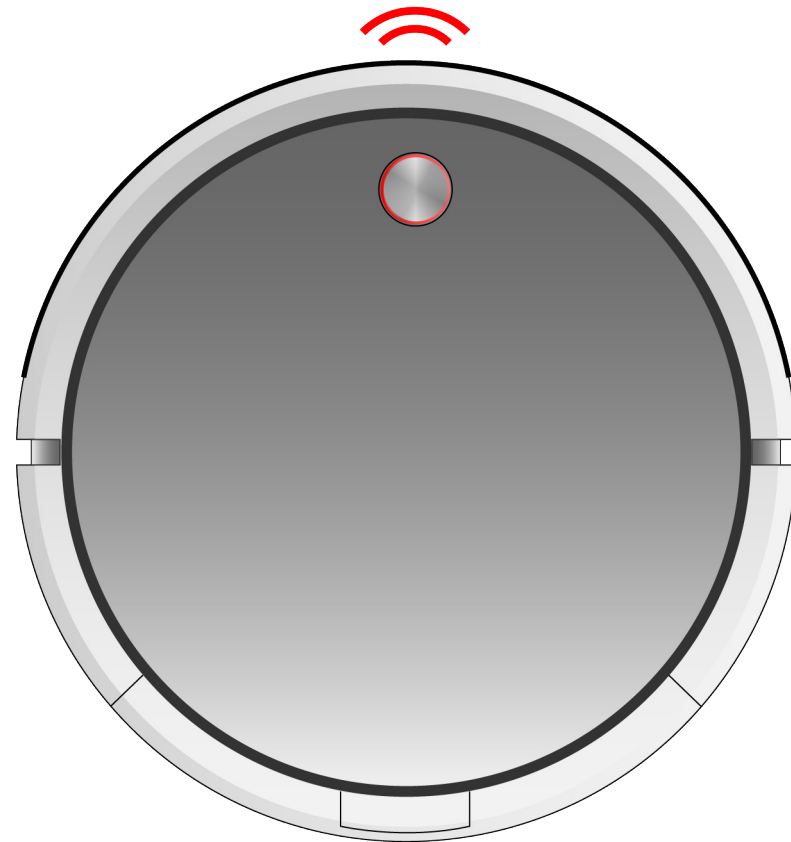

What to do:

1. Grip the wheel assembly with your hand and pull up. You may use a screwdriver for leverage if needed.
2. Remove the wheel by applying pressure to the back of it so that it pops out of place. Clean it thoroughly.
3. Replace the wheel and wheel assembly. Make sure the wheel spins freely inside the assembly.

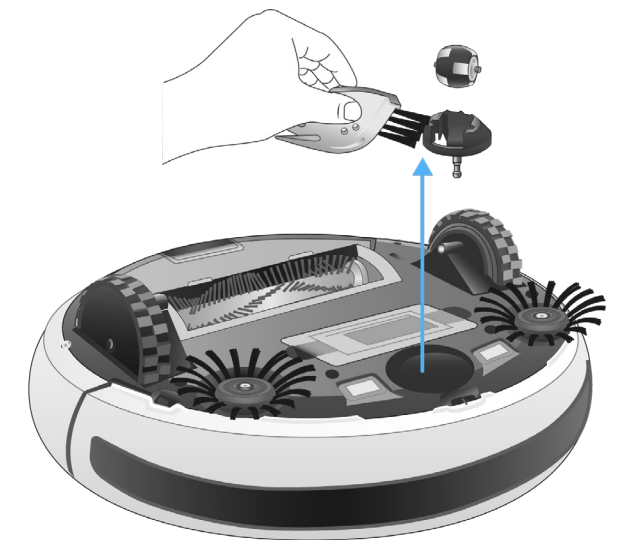

6 Red Light Flashes: Edge Sensors

If Bob stops working and flashes a red light 6 times between beeps, then his edge sensors may be dirty.

Parts You'll Need:

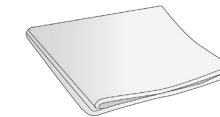

Cloth
(not included)

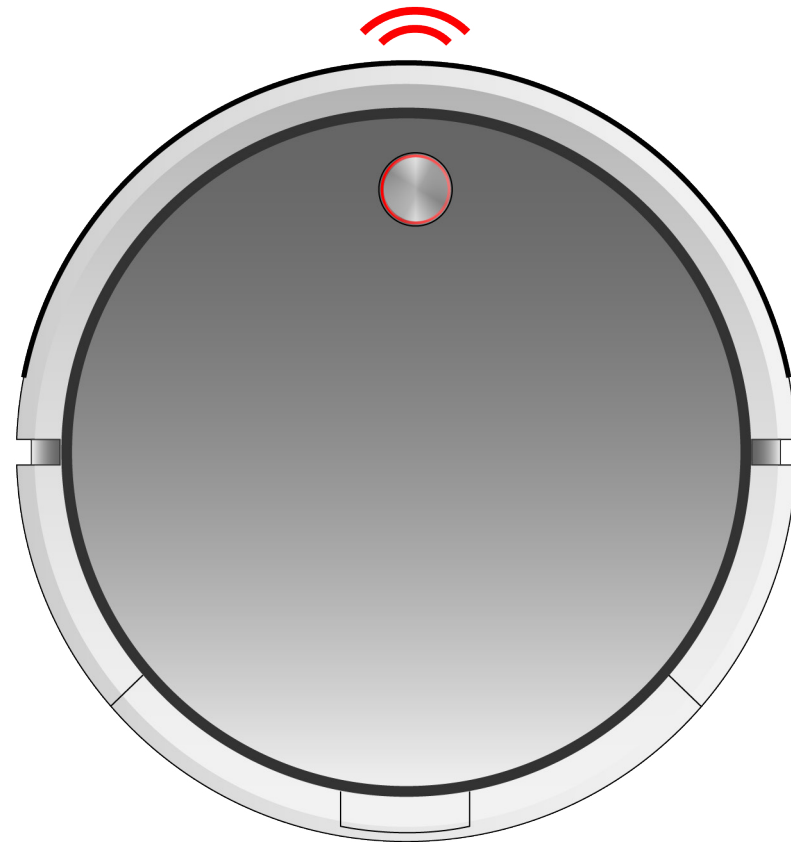

What to do:

Wipe the edge sensors using a soft cloth slightly dampened with cold water or alcohol.

Keep Bob away from dark carpet that interferes with his edge sensors.

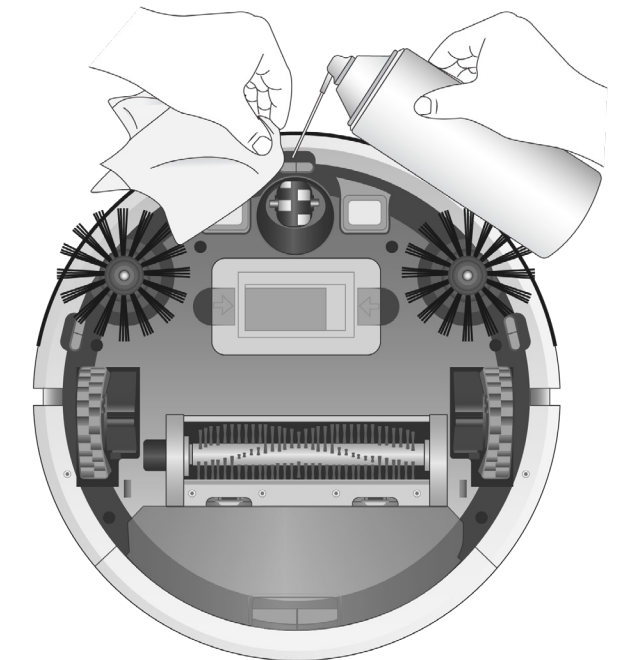

7 Red Light Flashes: Low Battery

If Bob stops working and flashes a red light 7 times between beeps, then his battery power is below 2%.

Parts You'll Need:

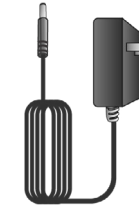

Power Adapter



Charging

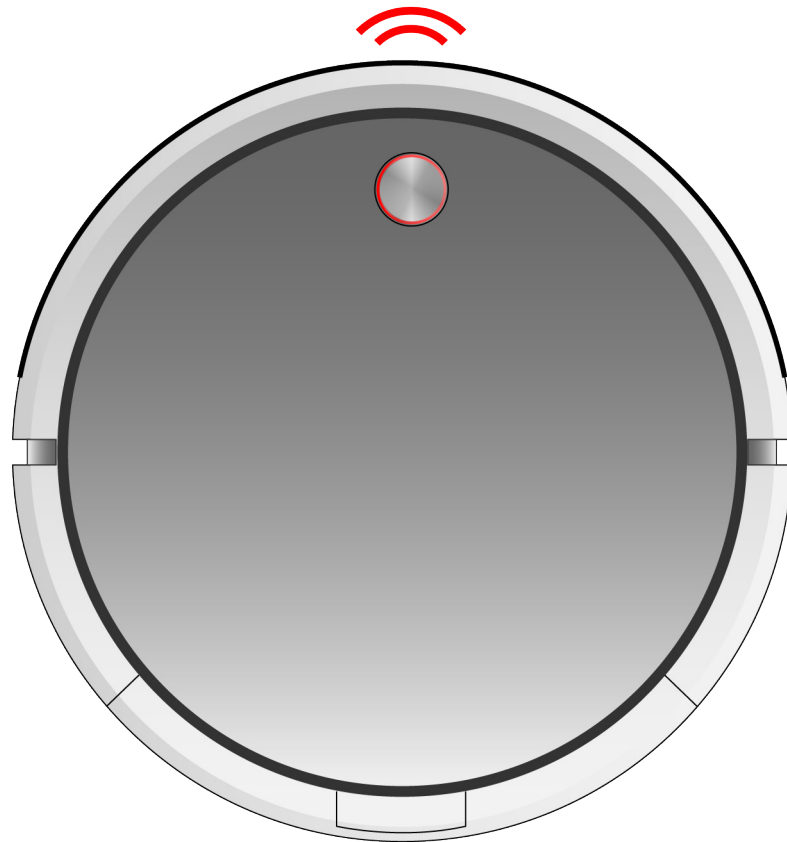

What to do:

Place Bob on his charging station with the metal plates on his underside sitting on top of the nodes on his station. Allow him to fully charge.

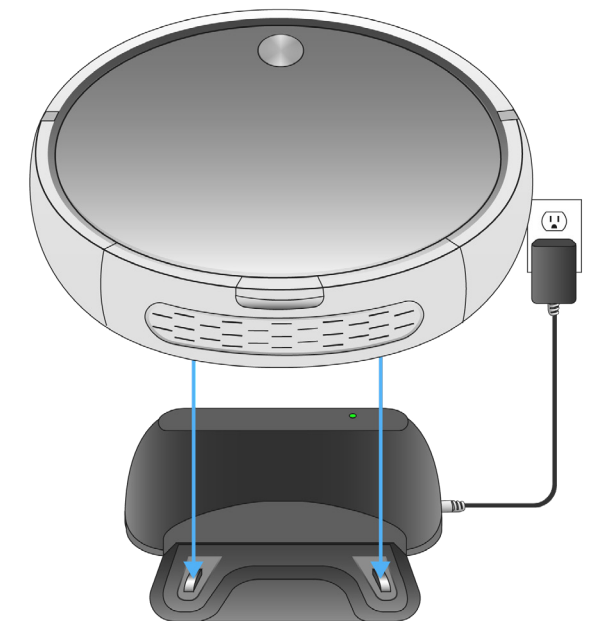

Bob will chirp once and slowly blink his cover button to let you know that he is charging.

When Bob has fully charged, his cover button will stop blinking and remain solid.

8 Red Light Flashes: Touch Sensors

If Bob stops working and flashes a red light 8 times between beeps, then his bumper may be congested.

Parts You'll Need:

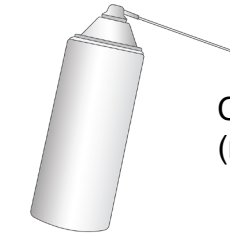

Compressed Air
(not included)

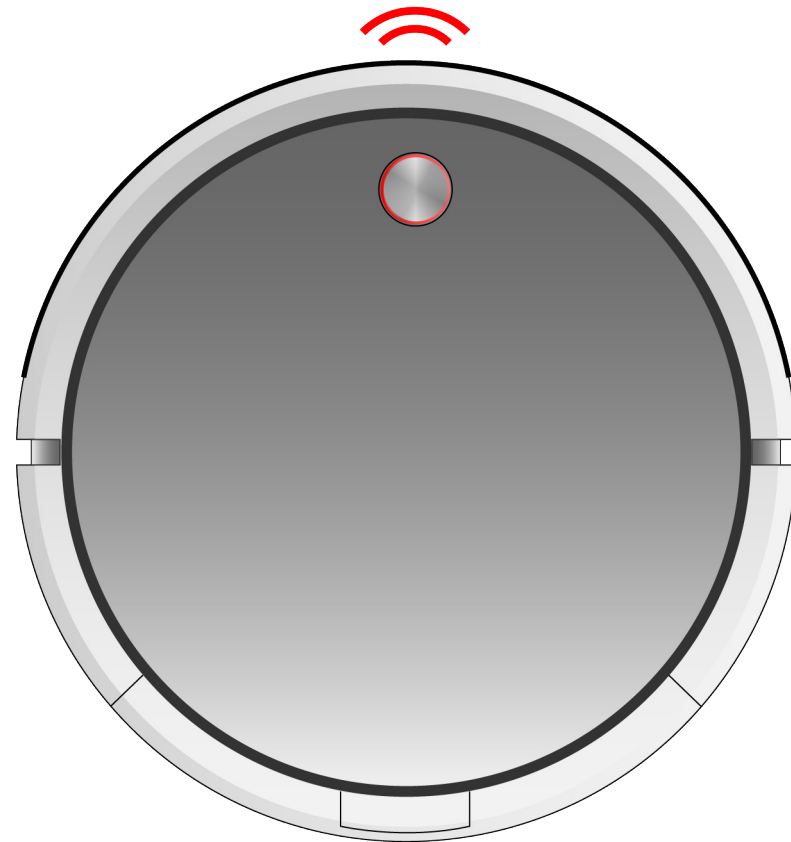

What to do:

Clean the inside of the bumper using compressed air.

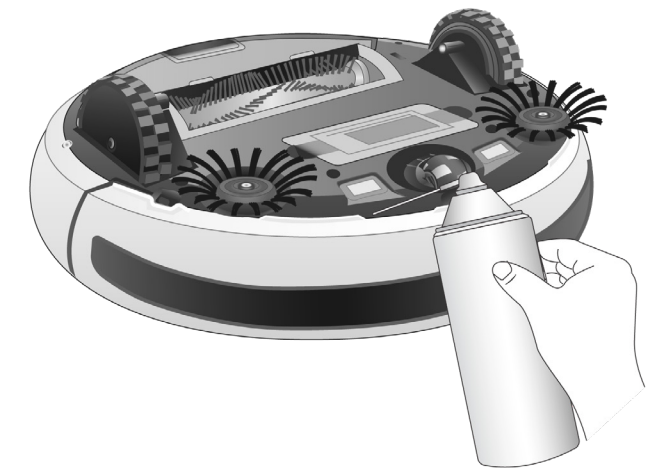

9 Red Light Flashes: Main Brush

If Bob stops working and flashes a red light 9 times between beeps, then his main brush may be congested.

Parts You'll Need:



Cleaning Tool

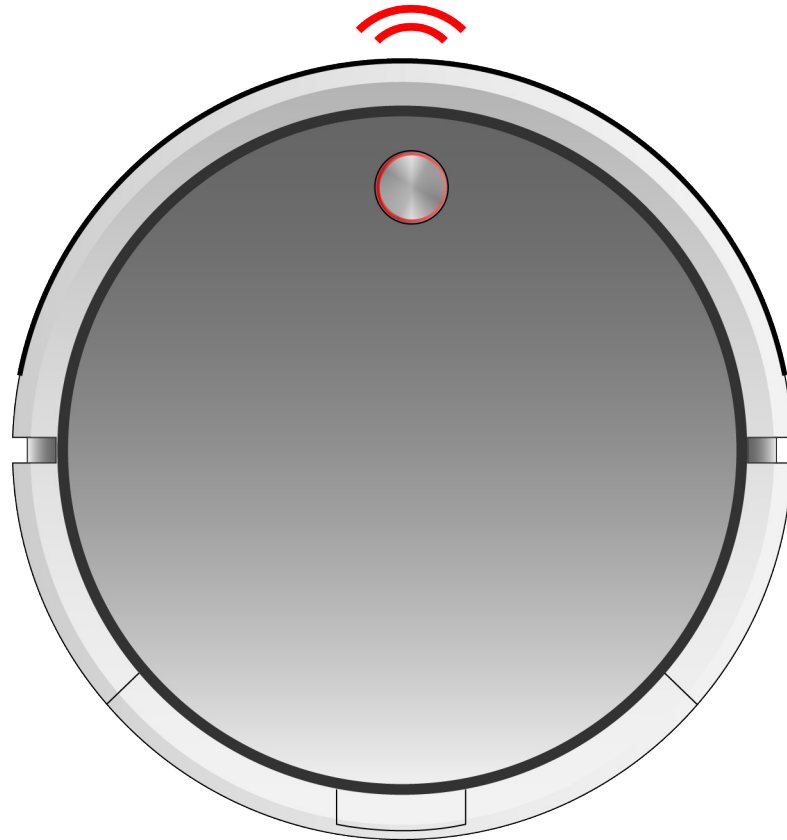

What to do:

1. Push in the tabs on the main brush frame and lift.
2. Use Bob's cleaning tool to clean the main brush and the notches inside Bob where the brush is held.
3. When done, secure the brush cap to the pin end of the main brush. Lastly, replace the main brush and main brush frame.

Quick Tips:

 You may use scissors to cut away entanglements of hair, or tweezers to unclog the notches inside Bob.

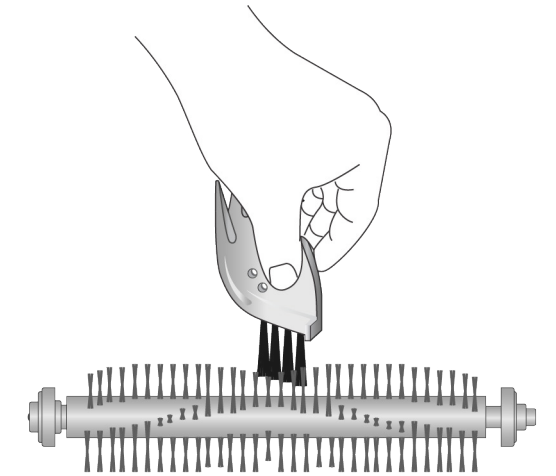

Bob's main brush is not designed to clean shag carpet or rugs with long fibers. If you'd like Bob to clean shag carpet or long-fibered rugs, you may remove his main brush and allow him to vacuum without it.

10 Red Light Flashes: Side Brush

If Bob stops working and flashes a red light 10 times between beeps, then his main brush may be congested.

Parts You'll Need:



Screwdriver



Cleaning Tool

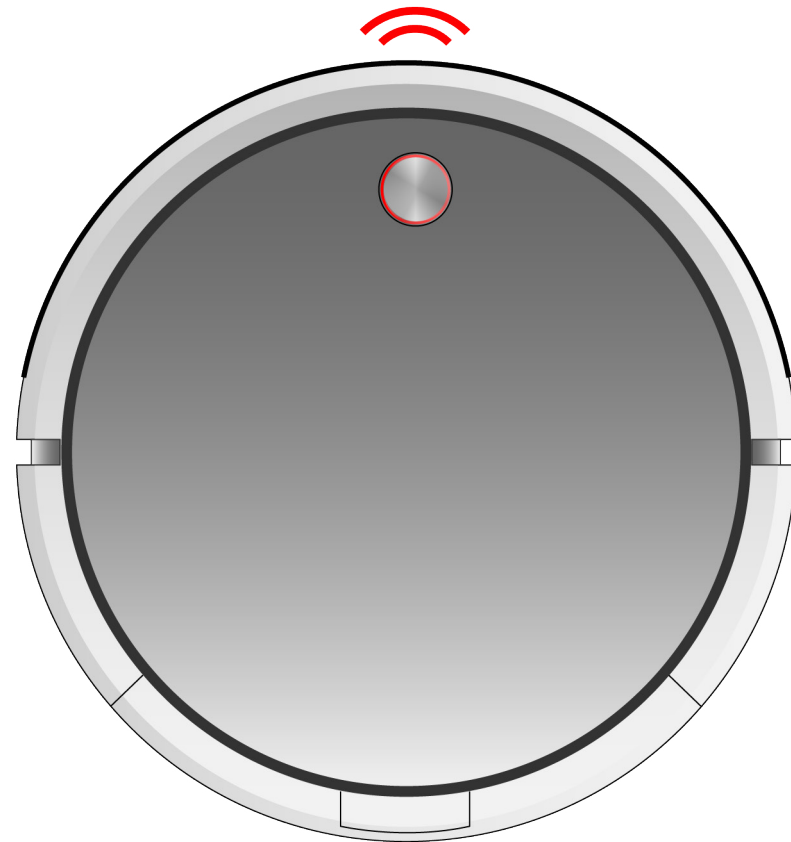

What to do:

1. Remove the screw on each side brush.
2. Use the cleaning tool to clean the side brushes and the brush sockets.
3. When done, replace the side brushes and screws.

Quick Tips:

 You may use scissors to cut away entanglements of hair, or tweezers to unclog the notches inside Bob.

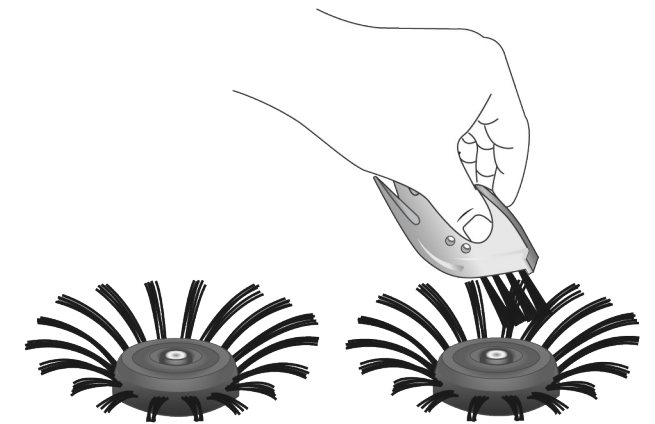

11 Red Light Flashes: Wall Sensors

If Bob stops working and flashes a red light 11 times between beeps, then his wall sensors may be dirty.

Parts You'll Need:



Compressed Air
(not included)

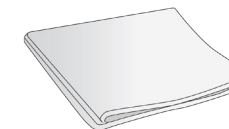

Cloth
(not included)

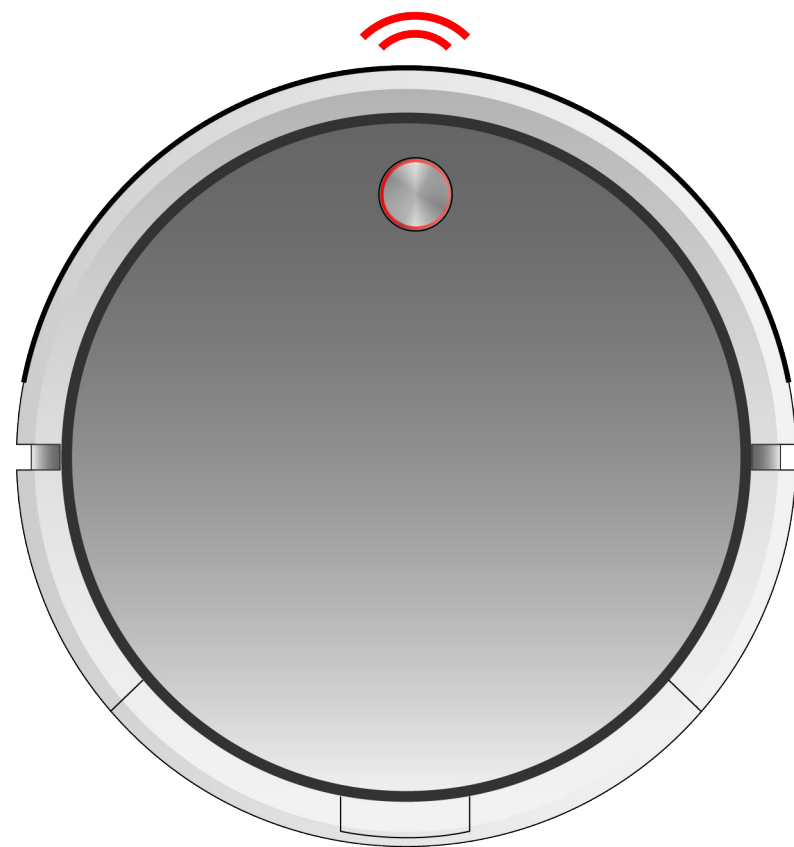

What to do:

Wipe the wall sensors using a soft cloth slightly dampened with cold water or alcohol. Bob's wall sensors are located along his bumper.

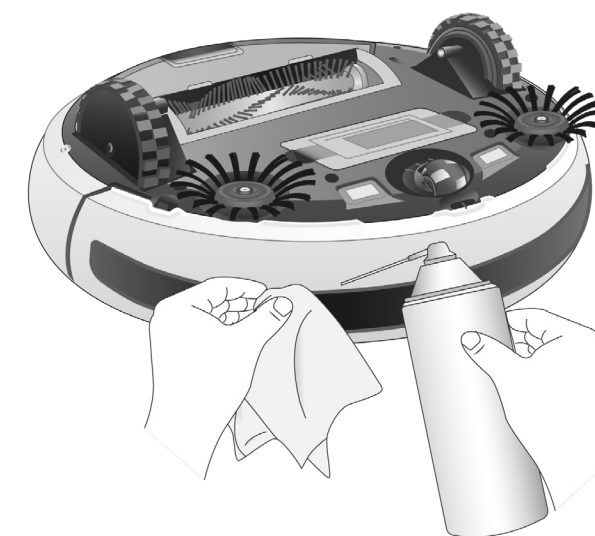

12 Red Light Flashes: Vacuum Motor

If Bob stops working and flashes a red light 12 times between beeps, then his vacuum motor is having an issue.

Parts You'll Need:

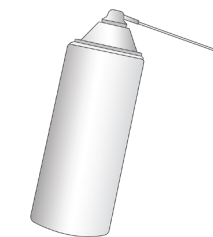

Compressed Air
(not included)

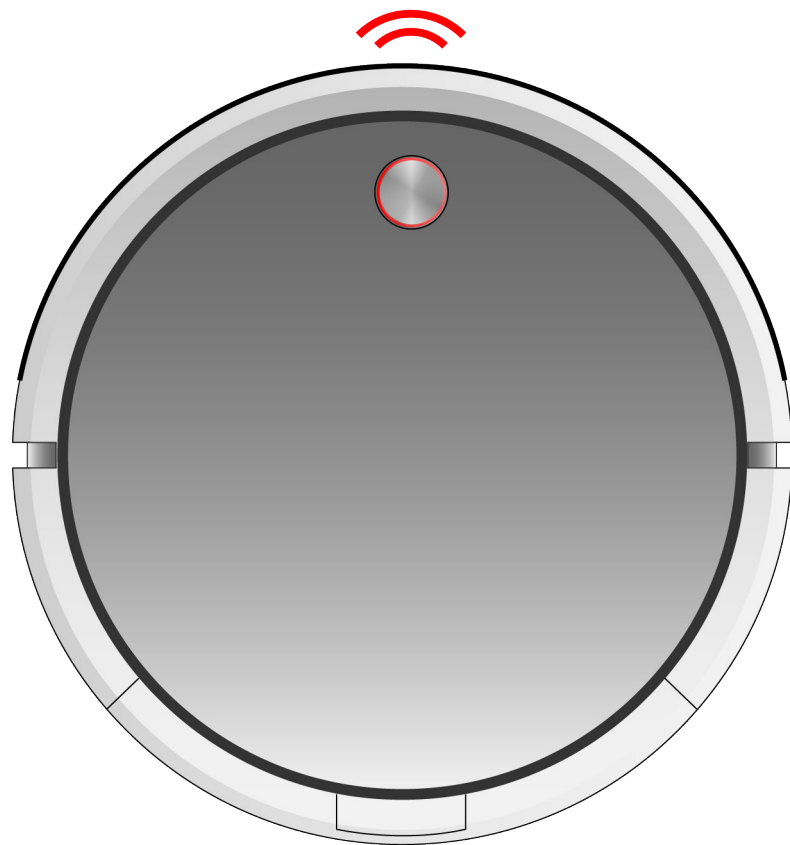

What to do:

Remove Bob's dustbin and clean the inside of Bob with compressed air.



14 Red Light Flashes: Power System

If Bob stops working and flashes a red light 14 times between beeps, then his power system is having an issue.

Parts You'll Need:

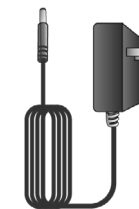

Power Adapter



Charging

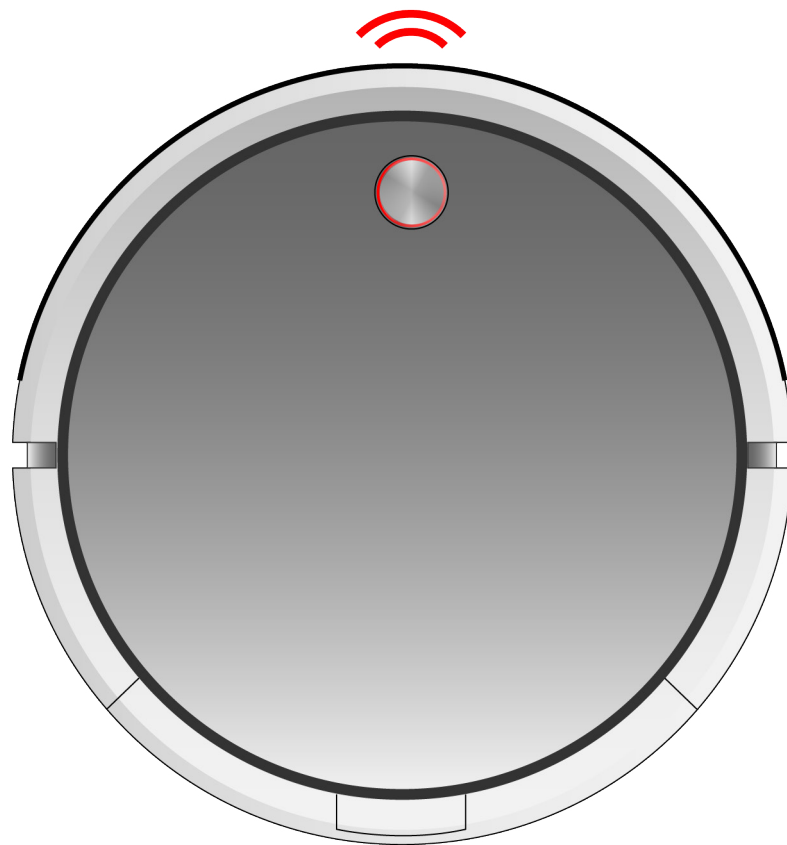

What to do:

1. Remove Bob's battery by pinching the tabs on the battery and pulling up. Unplug the battery, wait 10 seconds, and then replug it.
2. Inspect the charging adapter. Plug the charging adapter into the station. The green power light should turn on.
3. If the adapter appears to be working properly, place Bob on his station and leave him to fully charge.

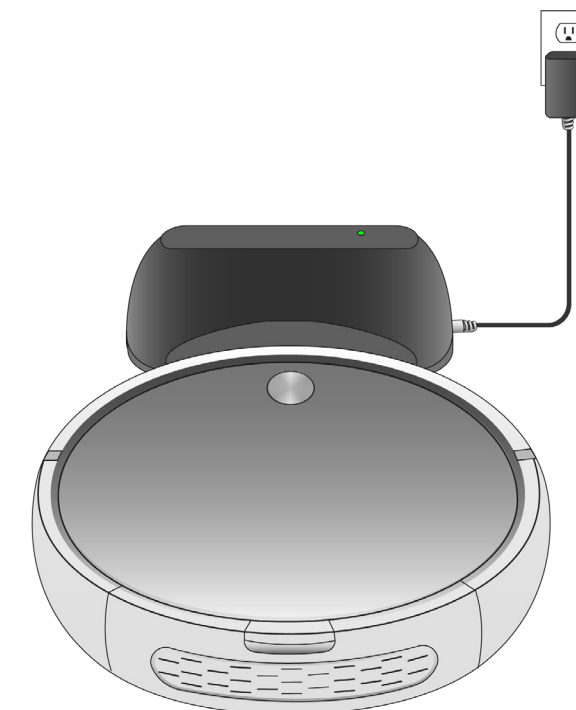

End User Agreement



IMPORTANT - READ BEFORE USING. Do not use the robot (“Bobsweep”) accompanying this license agreement (“Agreement”) until you have carefully read and agreed to the following terms and conditions. By using the Bobsweep, you agree to the terms of this End User License Agreement (“EULA”) and any amendment or addenda accompanying this Agreement. If you do not agree to the terms of this EULA, you may not use the Bobsweep. The Bobsweep contains an electronic and software interface that allows you to control or modify its behavior, and remotely monitor its sensors.

THIS IS A LEGAL AGREEMENT. BY ACCESSING AND USING THE PRODUCT AND PRODUCT SOFTWARE, YOU ARE ACCEPTING AND AGREEING TO THIS EULA ON BEHALF OF YOURSELF OR THE ENTITY YOU REPRESENT IN CONNECTION WITH THE ACCESS. YOU REPRESENT AND WARRANT THAT YOU HAVE THE RIGHT, AUTHORITY, AND CAPACITY TO ACCEPT AND AGREE TO THIS EULA ON BEHALF OF YOURSELF OR THE ENTITY YOU REPRESENT. YOU REPRESENT THAT YOU ARE OF SUFFICIENT LEGAL AGE IN YOUR JURISDICTION OR RESIDENCE TO USE OR ACCESS THE PRODUCT SOFTWARE AND TO ENTER INTO THIS EULA. IF YOU DO NOT AGREE WITH ANY OF THE PROVISIONS OF THESE TERMS, YOU SHOULD CEASE USING THE PRODUCT AND PRODUCT SOFTWARE.

Terms and Conditions

LICENSE: Subject to all of the terms of this Agreement, Bobsweep Inc. (“Bobsweep”) grants to you one (1) revocable, royalty-free, personal, non-exclusive, nontransferable, non-assignable, non-commercial intellectual property license to use the Bobsweep software contained on the Bobsweep, including the protocol for communicating with the Bobsweep software contained on the Bobsweep (“Bobsweep Software”), to use the Bobsweep.

NONCOMMERCIAL LICENSE: You may use the Bobsweep Software and the Bobsweep only for personal, noncommercial, educational, and research purposes. The Bobsweep Software and the Bobsweep may not be used for any other purpose, whether “for prot” or “not for prot.” Any work performed or produced using the Bobsweep, including Your Software, cannot be performed or produced for the benefit of other parties for a fee, compensation, or any other reimbursement or remuneration. A separate license is required for each additional use and/or individual user in all other cases. If you are an entity, Bobsweep grants you the right to designate one individual within your organization to have the sole right to use the Bobsweep Software and the Bobsweep in the manner provided above.

RESTRICTIONS: You agree not to: (i) use or copy the Bobsweep Software or the Bobsweep except as provided in this Agreement; (ii) rent or lease the Bobsweep Software or the Bobsweep to any third party; (iii) assign this Agreement or transfer the Bobsweep Software or the Bobsweep except as provided in this Agreement; (iv) modify, adapt, or translate the Bobsweep Software or the Bobsweep in whole or in part except as expressly provided in this Agreement; (v) reverse engineer, reverse compile, or disassemble the Bobsweep Software or the Bobsweep; or (vi) distribute, sublicense or transfer the source code form of Your Software and derivatives thereof to any third party except as provided in this Agreement.

YOUR SOFTWARE : Use and distribution of any software that you create for your Bobsweep (“Your Software”) is also subject to the following limitations: You (i) shall be solely responsible for any update or support obligation or other liability which may arise from your use or distribution, (ii) shall not make any statement that Your Software is “certied,” or that its performance is guaranteed, by Bobsweep, (iii) shall not use Bobsweep’s name or trademarks, (iv) shall prohibit disassembly and reverse engineering of the Bobsweep Software and the Bobsweep, (v) shall not publish reviews of Bobsweep products designated as beta without written permission from Bobsweep, and (vi) shall indemnify, hold harmless, and defend Bobsweep and its suppliers from and against any claims or lawsuits, including attorney’s fees, that arise or result from Your Software, including your use and your distribution.

TITLE: Title to the Bobsweep Software remains with Bobsweep or its suppliers. The Bobsweep Software is licensed, not sold. Except as expressly provided herein, Bobsweep does not grant any express or implied right to you under Bobsweep patents, copyrights, trademarks, or trade secret information. You will not remove any copyright or patent notice from the Bobsweep Software or the Bobsweep.

ONE-TIME TRANSFER: The initial user of the Bobsweep Software and the Bobsweep may make a one-time permanent transfer of this Agreement, the Bobsweep Software, and the Bobsweep to another end user, provided that the initial user retains no copies of the Bobsweep Software and the Bobsweep. This transfer must include the Bobsweep Software, the Bobsweep, and all of the materials accompanying the Bobsweep (including all component parts and printed materials, any upgrades, and this End User License Agreement document). The transfer may not be an indirect transfer, such as a consignment. Prior to the transfer, the end user receiving the Bobsweep Software and the Bobsweep must agree to all the terms of this Agreement.

NO WARRANTY AND LIMITED REPLACEMENT: EXCEPT AS STATED IN THE LIMITED WARRANTY TO THE ORIGINAL PURCHASER, THE BOBSWEEP SOFTWARE AND THE BOBSWEEP ARE PROVIDED “AS IS” WITH NO WARRANTIES, EXPRESS OR IMPLIED, INCLUDING BUT NOT LIMITED TO ANY IMPLIED WARRANTY OF MERCHANTABILITY, FITNESS FOR A PARTICULAR PURPOSE, NON-INFRINGEMENT OF INTELLECTUAL PROPERTY RIGHTS, OR ANY WARRANTY OTHERWISE ARISING OUT OF ANY PROPOSAL, SPECIFICATION, OR SAMPLE. NO ORAL OR WRITTEN INFORMATION OR ADVICE GIVEN BY BOBSWEEP OR ITS AGENTS SHALL CREATE A WARRANTY. If the Bobsweep Software or the Bobsweep is found to be defective in material or workmanship under normal use for a period of one (1) year from the date of receipt, Bobsweep’s entire liability and your exclusive remedy shall be the replacement of the Bobsweep Software or the Bobsweep. This offer is void if the defect results from accident, abuse, misapplication, or software that you developed for your Bobsweep. Any updates or supplements to the Bobsweep Software or the Bobsweep provided to you after the expiration of the one (1) year period are not covered by any warranty or condition, express, implied or statutory. **SOME JURISDICTIONS DO NOT ALLOW THE EXCLUSION OF IMPLIED WARRANTIES, SO THE ABOVE EXCLUSION MAY NOT APPLY TO YOU. LIMITATION OF LIABILITY: THE ABOVE REPLACEMENT PROVISION IS THE ONLY WARRANTY OF ANY KIND. BOBSWEEP OFFERS NO OTHER WARRANTY EITHER EXPRESS OR IMPLIED INCLUDING THOSE OF MERCHANTABILITY, NON INFRINGEMENT OF THIRD-PARTY INTELLECTUAL PROPERTY OR FITNESS FOR A PARTICULAR PURPOSE. NEITHER BOBSWEEP NOR ITS SUPPLIERS SHALL BE LIABLE FOR ANY DAMAGES WHATSOEVER (INCLUDING, WITHOUT LIMITATION, VICARIOUS LIABILITY, CONSEQUENTIAL DAMAGES, INCIDENTAL DAMAGES, DAMAGES FOR LOSS OF BUSINESS PROFITS, BUSINESS INTERRUPTION, LOSS OF BUSINESS INFORMATION, OR OTHER LOSS) ARISING OUT OF THE USE OF OR INABILITY TO USE THE BOBSWEEP SOFTWARE, THE BOBSWEEP, OR SOFTWARE THAT YOU DEVELOPED FOR YOUR BOBSWEEP, EVEN IF BOBSWEEP HAS BEEN ADVISED OF THE POSSIBILITY OF SUCH DAMAGES. BECAUSE SOME JURISDICTIONS PROHIBIT THE EXCLUSION OR LIMITATION OF LIABILITY FOR CONSEQUENTIAL OR INCIDENTAL DAMAGES, THE ABOVE LIMITATION MAY NOT APPLY TO YOU** **UNAUTHORIZED USE: THE BOBSWEEP SOFTWARE AND THE BOBSWEEP ARE NOT DESIGNED, INTENDED, OR AUTHORIZED FOR USE IN ANY AERONAUTICAL, NUCLEAR, MEDICAL, LIFE SAVING OR LIFE SUSTAINING SYSTEMS, OR FOR ANY OTHER APPLICATION IN WHICH THE USE OF THE BOBSWEEP SOFTWARE OR THE BOBSWEEP COULD CREATE A SITUATION WHERE PERSONAL INJURY OR DEATH MAY OCCUR.** Should you use the Bobsweep Software or Bobsweep for any such unintended or unauthorized use, you shall indemnify and hold harmless Bobsweep and its officers, subsidiaries and affiliates against all claims, costs, damages, and expenses, and reasonable attorney fees arising out of, directly or indirectly, any claim of product liability, personal injury or death associated with such unintended or unauthorized use, even if such claim alleges that Bobsweep was negligent regarding the design or manufacture of the Bobsweep Software, the Bobsweep, or any part or portion thereof.

USER SUBMISSIONS: You agree that any material, information or other communication, including all data, images, sounds, text, and other things embodied therein, that you transmit or post to a Bobsweep website or provide to Bobsweep (“Communications”) will be considered non-confidential. Bobsweep will have no confidentiality obligations with respect to the Communications. You agree that Bobsweep and its designees will be free to copy, modify, create derivative works, publicly display, disclose, distribute, license and sublicense through multiple tiers of distribution and licensees, incorporate and otherwise use the Communications, including derivative works thereof, for any and all commercial or non-commercial purposes without the payment of any royalty to you, and that such license will survive the termination of this Agreement.

TERMINATION: This Agreement becomes effective on the date you accept this Agreement and will continue until terminated as provided for in this Agreement. You may terminate this Agreement voluntarily at any time. Bobsweep may terminate this Agreement at any time if you are in breach of any of its terms and conditions, and may refuse to license the Bobsweep Software or the Bobsweep to you after termination. Upon termination by either party, you will immediately return to Bobsweep or destroy the Bobsweep Software and the Bobsweep and all your copies thereof. Articles 5 and 7 through 17 of this Agreement shall survive such termination. **U.S. GOVERNMENT RESTRICTED RIGHTS:** The Bobsweep Software and the Bobsweep are provided with “RESTRICTED RIGHTS.” Use, duplication or disclosure by the Government is subject to restrictions set forth in FAR52.227-14 and DFAR252.227-7013 et seq. or its successor. Use of the Bobsweep Software or the Bobsweep by the Government constitutes acknowledgment of Bobsweep’s rights in them.

NO EXPORT: You may not export the Bobsweep Software or the Bobsweep in violation of applicable export laws.

INTERPRETATION PROVISION: The provisions of this Agreement are severable. If any provision of this Agreement is held to be unenforceable, such provision shall be reformed only to the extent necessary to make it enforceable. Any law or regulation which provides that the language of a contract shall be construed against the drafter shall not apply to this Agreement.

INTEGRATION: This Agreement represents the complete agreement concerning the subject matter hereof, and any and all understandings, conversations and communications, proposals, and counterproposals, oral and written (including any draft of this Agreement) are merged into and superseded by this Agreement and shall be of no force or effect, except as expressly provided herein. No such understandings, conversations, communications, proposals, counterproposals or drafts shall be referred to in any proceeding concerning this Agreement. Further, no understanding contained in this Agreement shall be modified, altered or amended, except by a writing signed by the party against whom enforcement is sought.

ARBITRATION: All disputes relating to this Agreement (excepting any dispute relating to intellectual property rights) shall be subject to final and binding arbitration, with the losing party paying all costs of arbitration. Any arbitration relating to this Agreement shall be held in California, under the auspices of an arbiter selected by Bobsweep. Any litigation relating to this Agreement shall be subject to exclusive venue and jurisdiction in the federal and state courts of California, with the losing party responsible for costs, including without limitation, court costs and reasonable attorneys fees and expenses.

APPLICABLE LAWS: Any claim arising under or relating to this Agreement shall be governed by the internal substantive laws of the Commonwealth of California, without regard to its principles of conflict of laws. The application of the United Nations Convention on Contracts for the International Sale of Goods is expressly excluded.

bObsweep

® and © bObsweep Inc. All rights reserved.