



bObi Pet™

OWNER'S MANUAL

Congratulations!

Congratulations on your new intelligent floor cleaner! bObi is now at your service. To see bObi at her best, please read the Quick Start Guide and this manual thoroughly. Welcome to the bObsweep family and happy cleaning!

If you have any questions or concerns, feel free to contact our helpful team at: support@bobsweep.com or [1-888-549-8847](tel:1-888-549-8847) for support in the US & Canada.

Our business hours are Monday – Friday 9 am – 5 pm, PST.

5

Important Safety
Instructions

7

Box Contents

9

Anatomy

13

Get bObi
Ready to Clean

Installing Battery
First Charge
First Cleaning
Touchscreen Buttons

20

Charging Station

Placement
Auto Charging
Syncing Station
Manual Charging

25

blOck™

Defining Boundaries
Syncing blOck™
blOck™ Placement

32

Remote Control

Controls
Syncing Remote

37

Setting bObi's Cleaning Schedule

Remote Screen
Set Current Time
Set Cleaning Schedule
Auto-Resume

48

Parts & Maintenance

Mini Mop
Dustbin
Main Brushes
Side Brush
UV Light
Front Wheel
Sensors
Blindfold Stickers
Storage

65

Troubleshooting & Checkup Test

Error Codes
Home Checkup Test
Cleaning Behavior

84

Warranty Information & FAQs

89

End User License Agreement

Important Safety Instructions

Basic safety precautions should always be followed, including the following:

- To protect against electrical shock, do not immerse any part of bObi — with the exception of her mopping cloth — into water or other liquids. bObi's dustbin may be washed with water only once her motor has been removed.
- Turn bObi OFF and unplug her from outlet when she is not in use and before conducting maintenance.
- If bObi, her remote control, charging station, or bLOck has been damaged, do not operate them. Contact our customer care center at support@bobsweep.com.
- Do not handle bObi, her remote control, bLOck (not included), or her charging station with wet hands; use only on dry surfaces.
- Do not use bObi outdoors.
- bObi is not intended for use by persons (including children) with reduced physical or mental capabilities, or lack of experience and knowledge, unless under the close supervision of a person responsible for their safety.
- Do not pull or carry the charging station by the cord, use the cord as a handle, close a door on the cord, or pull the cord around sharp edges or corners. Keep the cord away from heated surfaces. To unplug the cord grasp the plug, not the cord.
- Do not mutilate or incinerate the battery, as it will explode at high temperatures.
- Leaks from battery cells can occur under extreme usage or temperature conditions. If the liquid gets on skin, wash quickly with water. If the liquid gets into the eyes, flush them immediately with clean water for a minimum of 10 minutes, and seek medical attention.
- Do not dispose of your battery in fire. Old batteries should be recycled safely (check with your local recycler).
- Do not attempt to open the charging station. Repairs on the station should only be carried out by our qualified customer care center.
- Do not expose bObi, her remote control, or charging station to temperatures higher than 113° F (45° C), moisture, or humidity.
- Do not let bObi pick up toxic materials (chlorine bleach, ammonia, drain cleaner, etc.).
- Do not let bObi pick up anything that is burning or smoking, such as cigarettes, matches, or hot ashes. Do not use bObi to pick up flammable or combustible liquids such as gasoline, nor use her in areas where they may be present.
- Do not use bObi in an enclosed space filled with vapors given off by oil-based paint, paint thinner, moth-proofing substances, flammable dust, or other explosive or toxic vapors.

- bObi is composed of electronic components that in rare and unintended cases can cause hazards of heating, fire, and other malfunctions. Furthermore, because bObi is capable of and intended for autonomous movement and cleaning, her use poses the risk of collision with property, pets, and persons and unintended removal of articles, such as small valuables, jewelry, or hair of persons or pets lying on the floor, among others.
- Do not look directly into the UV light.
- Do not use bObi for other than intended usage.

Declaration of Conformity

This device complies with Part 15 of the FCC rules. Operation is subject to the following two conditions: (1) this device may not cause harmful interference, and (2) this device must accept any interference received, including interference that may cause undesired operation.

The manufacturer is not responsible for any radio or TV interference caused by unauthorized modifications or change to this equipment. Such modifications or change could void the user's authority to operate the equipment.

This equipment has been tested and found to comply with the limits for a Class B digital device, pursuant to part 15 of the FCC Rules. These limits are designed to provide reasonable protection against harmful interference in a residential installation. This equipment generates, uses and can radiate radio frequency energy and, if not installed and used in accordance with the instructions, may cause harmful interference to radio communications. However, there is no guarantee that interference will not occur in a particular installation. If this equipment does cause harmful interference to radio or television reception, which can be determined by turning the equipment off and on, the user is encouraged to try to correct the interference by one or more of the following measures:

- Reorient or relocate the receiving antenna.
- Increase the separation between the equipment and receiver.
- Connect the equipment into an outlet on a circuit different from that to which the receiver is connected.
- Consult the dealer or an experienced radio/TV technician for help.

Box Contents

- 1 bObi, Your Intelligent Floor Cleaner
- 2 Charging Station
- 3 Spare Main Brush
- 4 Charging Adapter
- 5 Remote Control
- 6 bObi bLOCK™
- 7 Spare Side Brush
- 8 Cleaning Tool
- 9 Pack of Screws
- 10 Blindfold Stickers
- 11 Mini-Mop Attachment
- 12 Mopping Cloths
- 13 Spare Filter
- 14 Owners' Manual, Quick Start Guide, Warranty Card
- 15 Syncing Tool
- 16 Screwdriver
- 17 2 Spare Main Brush Holders

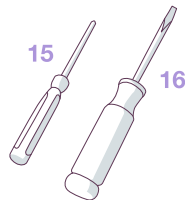
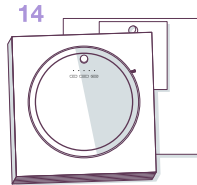
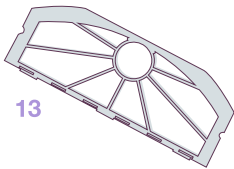
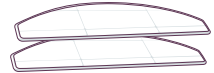
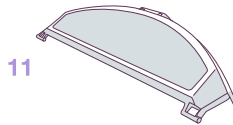
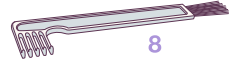
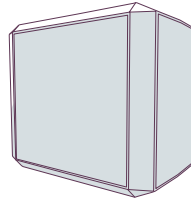
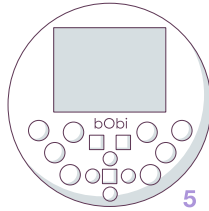
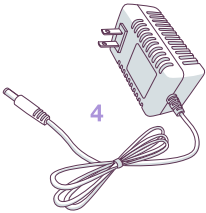
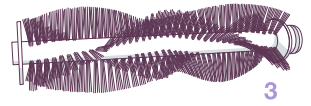
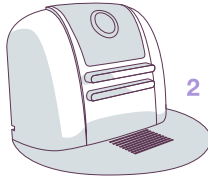
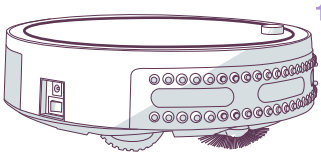

Anatomy

Top View

- 1 Cover
- 2 Touchscreen Buttons
- 3 Transmitter
- 4 Charging Indicator
- 5 Touch Sensors
- 6 Wall Sensors
- 7 Charging Inlet
- 8 Power Switch

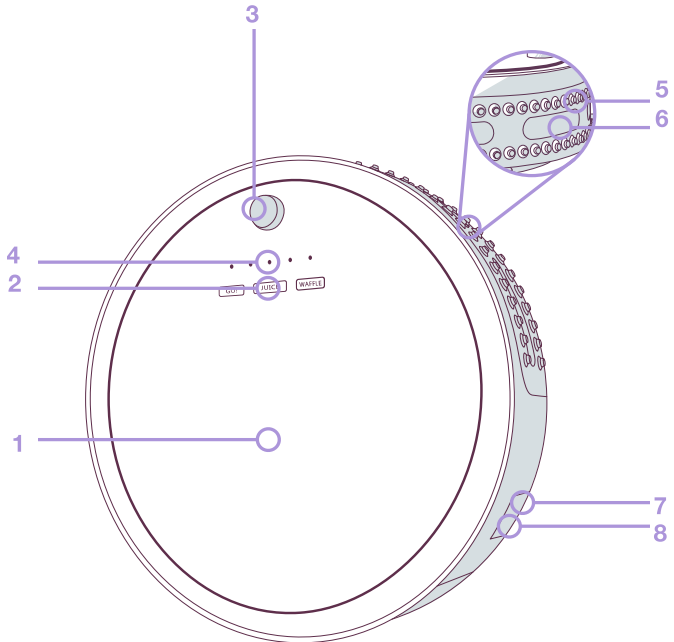

Bottom View

- 1 Main Brush
- 2 Rubber Brush
- 3 Dustbin
- 4 Right Wheel
- 5 Left Wheel
- 6 Side Brush
- 7 Edge Sensors
- 8 Front Wheel
- 9 UV Light
- 10 Battery

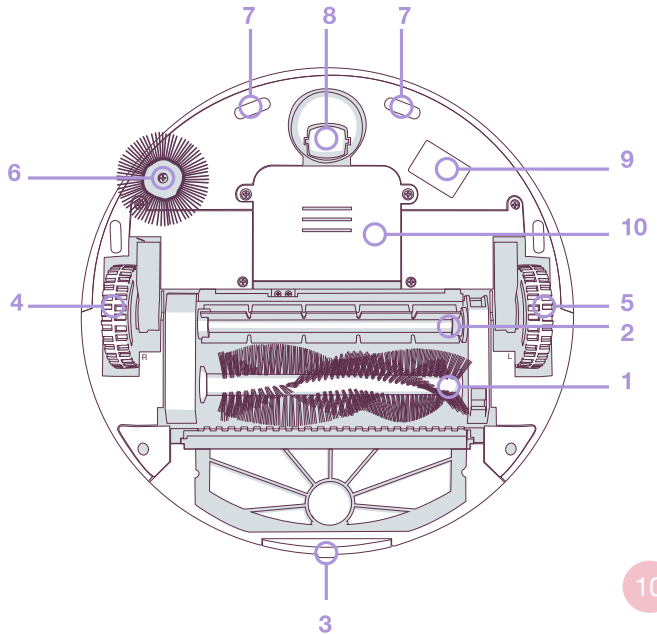

- 1 Charging Station
- 2 Remote Control
- 3 bLOck™

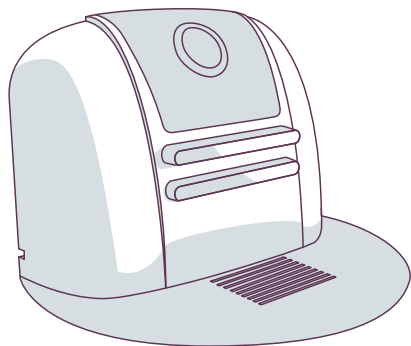

1

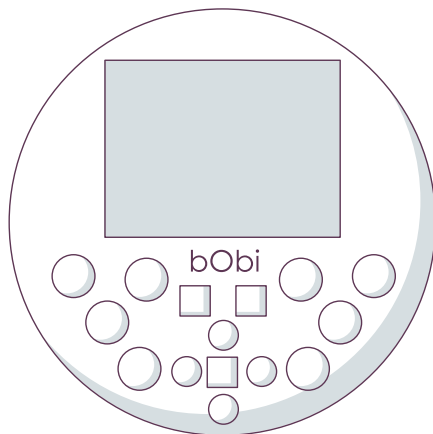

2

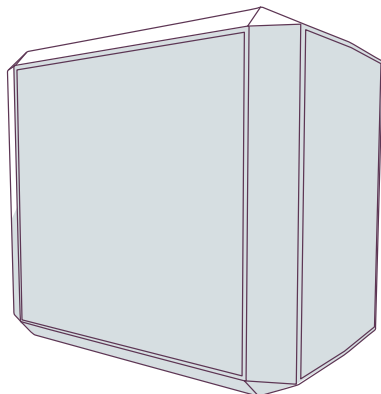

3

Touchscreen Buttons

1 GO!

bObi will clean on her default cleaning mode

2 JUICE

bObi will search for her charging station to refuel

3 WAFFLE

bObi will clean localized mess

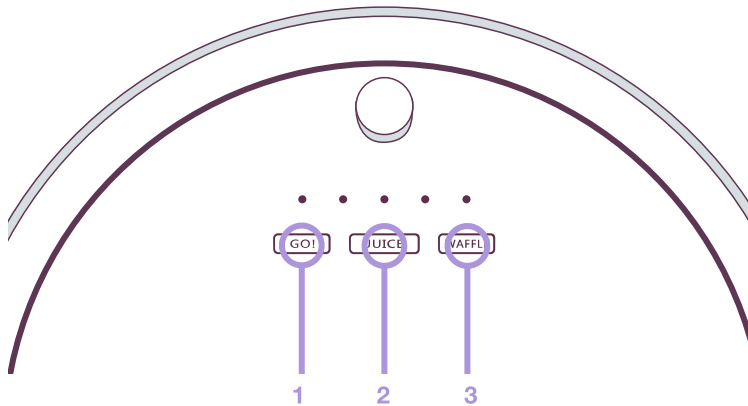

**Get bObi
Ready to Clean**

Install bObi's Battery

Before bObi's first clean, you must install her battery. Make sure bObi's power switch is turned OFF.

1

Remove the battery cover using a Phillips head screwdriver.

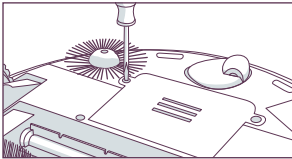

2

Plug the battery in at the circuit junction. Tuck the wire into the side of the compartment and slide the battery in.

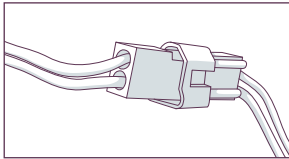

3

Replace the cover and re-tighten the screws.

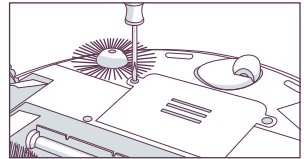

After installing bObi's battery, charge bObi for 8 hours before first use.

Charge bObi

1

Plug the charging adapter into the side of the charging station. The station's power light will turn on.

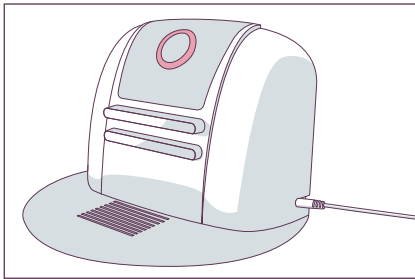

2

Place bObi on her charging station with the metal nodes on her front resting against the plates on her station.

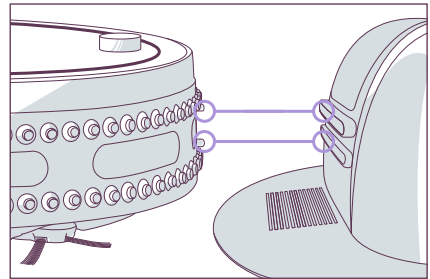

bObi will chirp, her lights will flash, and the center light will blink to indicate that she is charging. The other lights will disappear.

The center light on bObi will remain solid when she is fully charged and ready to clean.

Alternatively, you may charge bObi by plugging the charging adapter into the inlet above her power switch.

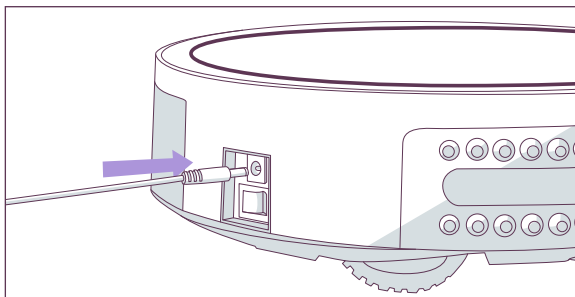

bObi's First Clean

bObi is now ready to clean!

Flip her power switch ON, and press the GO! button on her cover or remote. bObi will clean on her default setting.

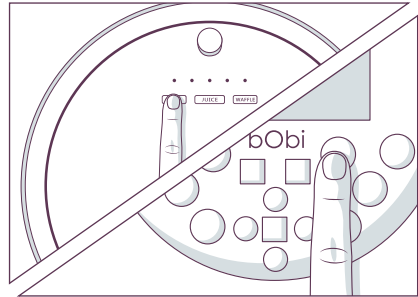
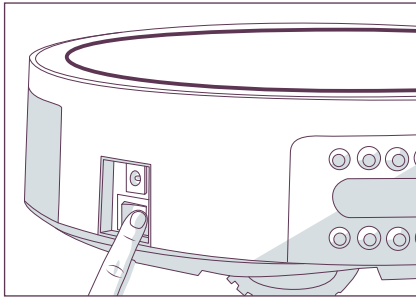

If bObi is left idle with her power switch ON, her screen will go blank and she will enter standby mode. To wake bObi, tap her touchscreen. To fully power off bObi, flip her power switch OFF.

Clear the area of small items and cords before asking bObi to clean.

Touchscreen Buttons

There are three touchscreen buttons on bObi: GO!, JUICE, and WAFFLE.

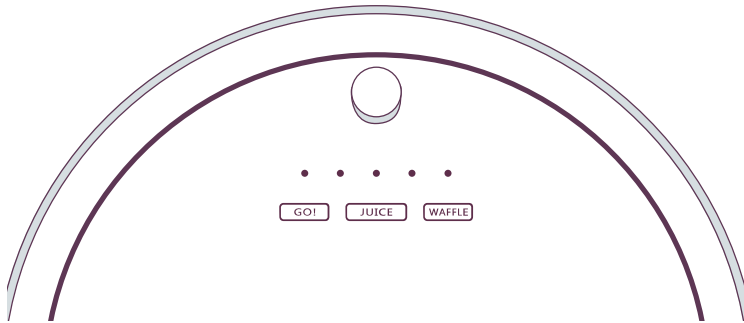

These buttons do not work while bObi is on her charging station. To use these buttons, you must first remove bObi from her charging station.

Alternatively, you can use bObi's remote to select her cleaning modes without needing to remove her from her charging station.

GO!

GO! is bObi's default cleaning mode. bObi will clean a large area until her battery reaches 15% capacity, and then she will return to her charging station.

JUICE

JUICE tells bObi to return to her charging station. bObi will not clean while in JUICE mode.

WAFFLE

WAFFLE can be used to clean up small spills of dry substances. bObi will clean an area of 10 square feet (1 square meter) for about 1 – 3 minutes before she stops and enters standby mode.

Charging Station

Charging Station Placement

- Position bObi's charging station against a wall on a hard, flat surface.
- Make sure that there is at least 10 feet (3 m) of open space in front of the charging station and 2 feet (0.5 m) on either side of the station.

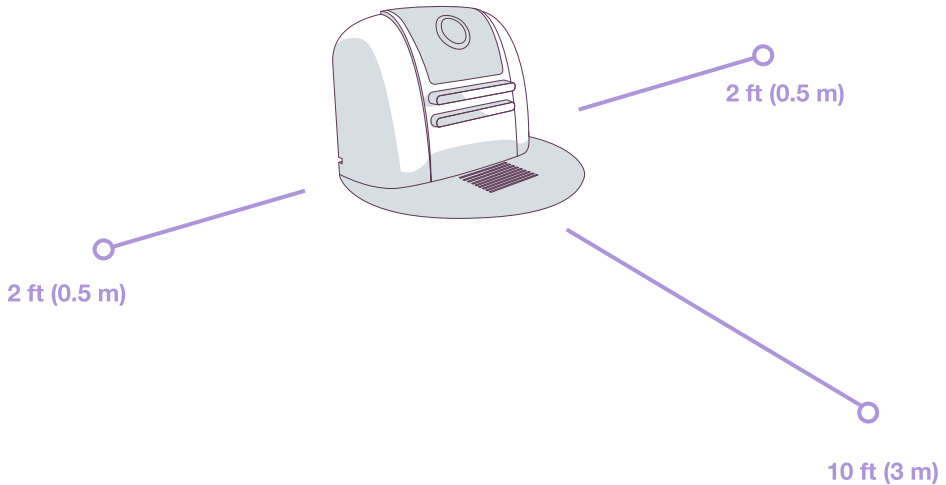

Secure bObi's charging adapter behind her station so the cord does not get in her way while she is cleaning.

Auto Charging

bObi automatically searches for her charging station when her battery reaches 15% capacity. She will chirp, stop vacuuming, and display JUICE on her cover while searching. When bObi detects her charging station, she will line herself up, dock, and begin to charge.

If bObi has trouble finding her station, you likely need to sync the station.

To sync the charging station:

1

Flip bObi's power switch OFF.

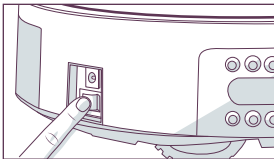

2

Plug the adapter into the charging station.

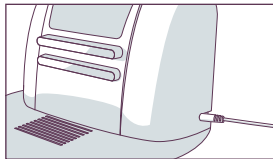

3

Use the syncing tool that came in bObi's box to press the sync button on the back of the station.

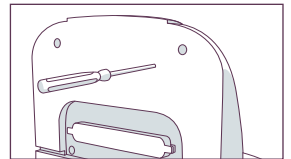

4

While still pressing the sync button, flip bObi's power switch ON.

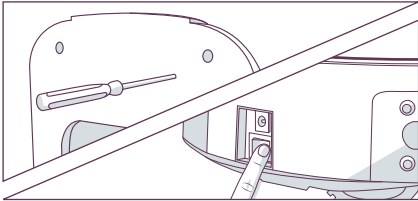

5

bObi will chirp twice to let you know the sync was successful.

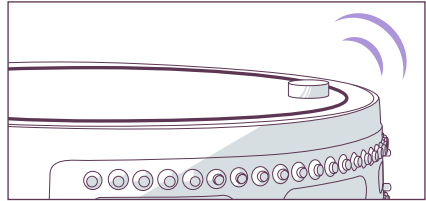

Direct bObi to her charging station at any time by pressing the JUICE button on her cover or remote.

To prolong bObi's battery life, flip her power switch OFF when not in use.

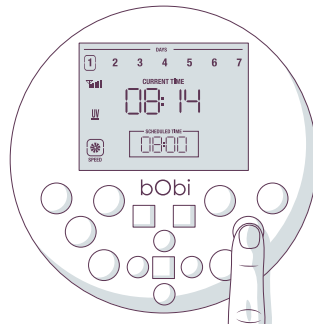

Manual Charging

Using the charging station:

- Place bObi on her charging station with the metal nodes on her front resting against the plates on her station.

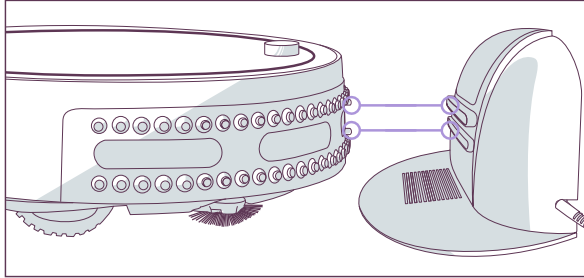

Using the adapter:

- Plug the charging adapter directly into the inlet above bObi's power switch.

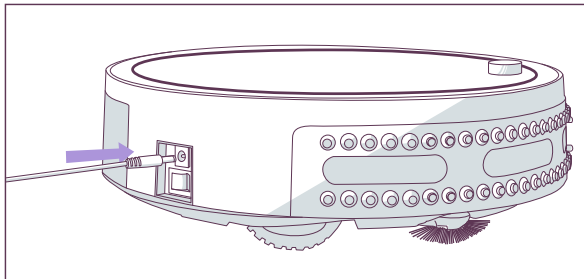

blOck™

bIOck™

If you need to keep certain areas out of bObi's reach, you can use bIOck™ to create a digital barrier that bObi will not cross. bIOck™ runs on 4 AA batteries (not included).

A digital barrier is emitted from the front of bIOck™. There are two buttons on the back of bIOck™:

- 1 Power Button
- 2 Sync Button

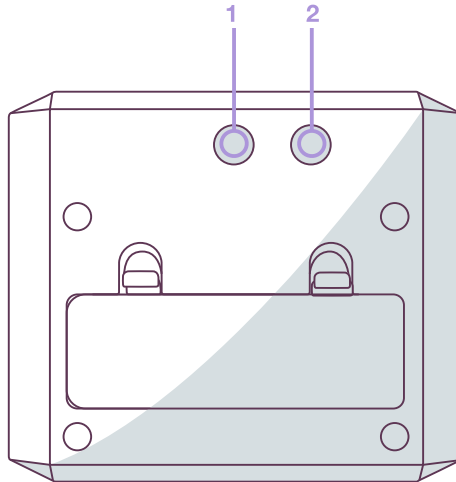

To set up digital barriers with bOck™:

Press the power button. The red power light on the front of bOck™ will turn on, stay on for 10 seconds, and then slowly blink every 3 seconds.



When bOck™ is low on battery, the power light flashes more quickly than usual to indicate that it needs new batteries. To conserve battery, switch bOck™ OFF when not in use.

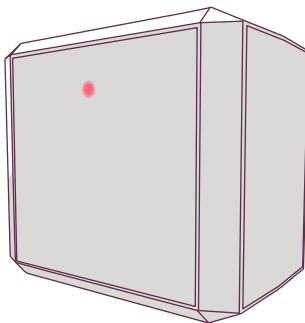

bOck™ remains ON for 3 hours before automatically turning OFF to conserve battery.

To turn bLock™ OFF:

Press the power button again. The red power light on the front of bLock™ will disappear.

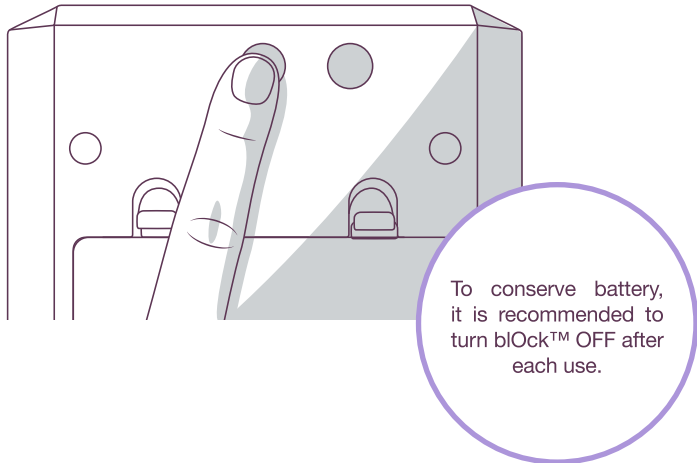

If bObi does not respond to her bOck™, bOck™ likely needs to be synced.

To sync bOck™:

1

Switch both bObi and bOck™ OFF.

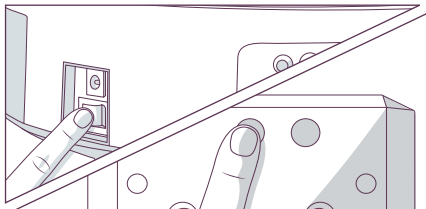

2

Press the power button on the back of block™.

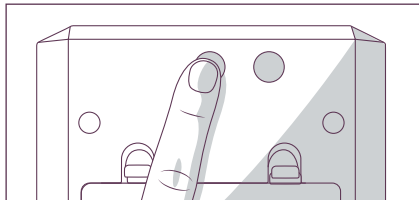

The power light on the front of bOck™ will turn on, stay still for 10 seconds, and then slowly blink every 3 seconds.

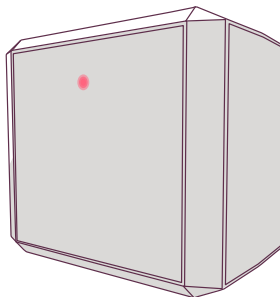

3

While holding down bLock™'s sync button, flip bObi's power switch ON.

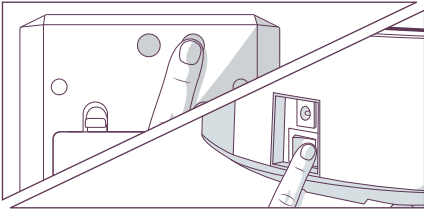

4

bObi will chirp twice to let you know the sync was successful.

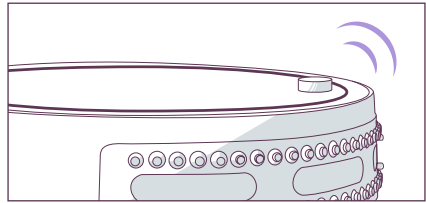

You can sync multiple
bLocks™ with bObi.

bIOck™ Placement

bIOck™ emits its digital barrier from the front. The front of bIOck™ is the side where the red power light is.

Position bIOck™ with its front facing the direction you would like to create a barrier. For example, see the image below where bIOck™ is placed at the opening of a doorway.

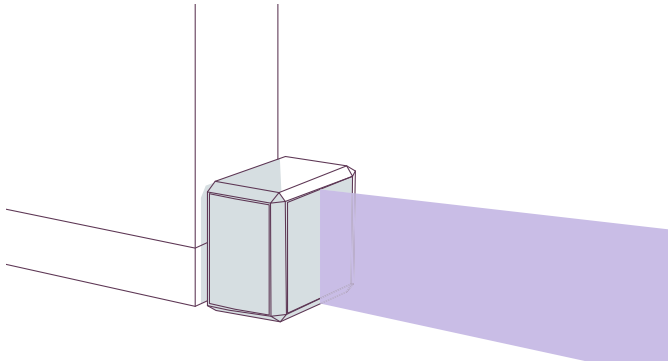

bIOck™ creates a barrier measuring about 10 ft. The barrier's signal gradually weakens at the far end.

Remote Control

Remote Control

The remote control is your most useful tool when communicating with bObi. It allows you to set bObi's cleaning schedule and activate her cleaning modes. Each time you select an action on the remote, bObi will chirp once before performing the selected action.

- 1 CUR TIME (Current Time)
- 2 SCH TIME (Schedule Time)
- 3 ALL/NONE
- 4 UV
- 5 HI/BYE
- 6 OK
- 7 Navigational Arrows
- 8 STOP
- 9 SPEED
- 10 JUICE
- 11 WAFFLE
- 12 GO!

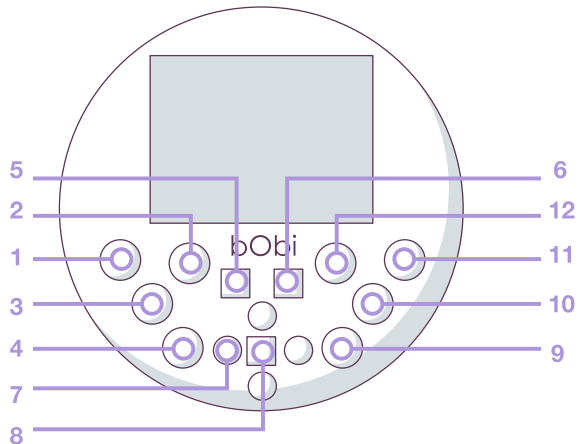

CUR TIME (Current Time)

- Sets the current time and weekday.

SCH TIME (Schedule Time)

- Sets bObi's cleaning schedule.

ALL/NONE

- Selects/deselects all weekdays.

UV

- Turns bObi's UV light ON and OFF.

HI/BYE

- Puts bObi in and out of standby mode.

OK

- Confirms selection.

Navigational Arrows

- Guide bObi forward, backward, left, and right.

STOP

- Pauses or resumes bObi's movement.

SPEED

- Alternates between bObi's two speeds.

JUICE

- Sends bObi to her charging station.

WAFFLE

- bObi will clean a localized mess.

GO!

- bObi will clean on her default cleaning mode.

Syncing bObi with her Remote

bObi's remote control requires two AAA batteries (not included). Do not leave the batteries in the remote if you are not using it on a regular basis. Keep the remote at room temperature. If bObi is not responding to her remote, it likely needs to be synced.

To sync the remote:

1

Flip bObi's power switch OFF.

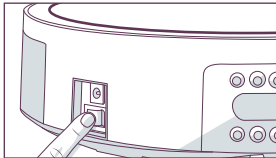

2

While holding down the OK button on bObi's remote, flip bObi's power switch ON.

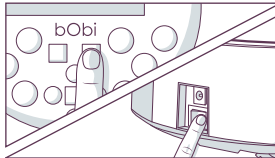

3

bObi will chirp twice to let you know the sync was successful.

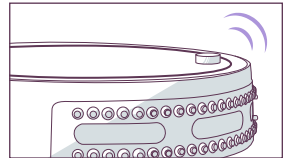

If bObi does not chirp, repeat the process.

Using the navigational arrows:

Hold down the remote's navigational buttons to keep bObi moving in the desired direction. Release the button when you are done manually driving bObi.

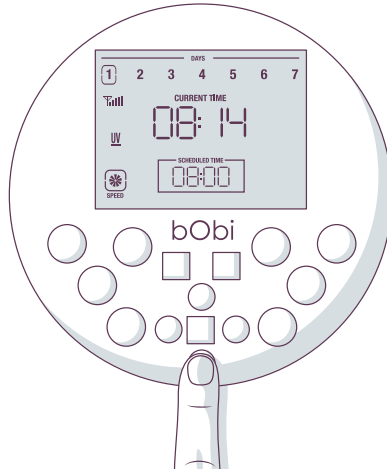

bObi's edge sensors are located along her front, not along her back. Do not reverse bObi towards edges, as she will fall.

Cleaning Schedule

Set bObi's Cleaning Schedule

bObi can be programmed to start cleaning on the days and time of your choosing through her remote control. To set bObi's cleaning schedule up, you must first set the current time and weekday on her remote.

- 1 Weekdays
- 2 Signal Indicator
- 3 UV Indicator
- 4 Speed Indicator
- 5 Current Time
- 6 Scheduled Time

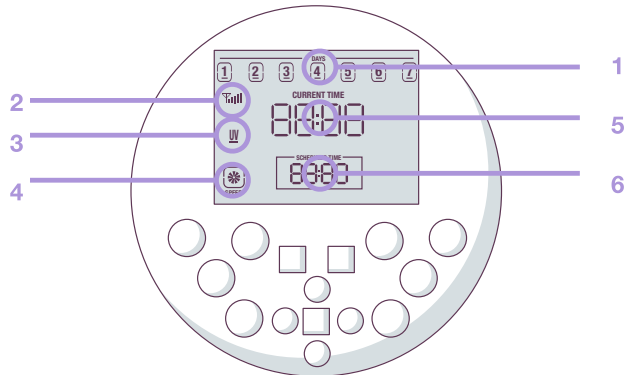

Weekdays

- The numbers 1 to 7 on the top of the screen represent days of the week.
1= Monday 2= Tuesday 3= Wednesday 4= Thursday
5= Friday 6= Saturday 7= Sunday

Signal Indicator

- Lights up when bObi and her remote communicate.

UV Indicator

- Indicates if the UV light is on or off.

Speed Indicator

- Indicates bObi's current cleaning speed.

Current Time Indicator

- Displays the current time.

Scheduled Time

- Displays bObi's scheduled cleaning time.

bObi uses a 24-hour clock. If you want bObi to start cleaning at 8:00 AM, set her scheduled time to 08:00. If you want her to start at 8:00 PM, set it to 20:00.

8:00 AM is the default time. This time is displayed after installing new batteries in the remote.

Setting the Current Time

To set the current time on bObi's remote:

1

Make sure bObi's power switch is ON. Press the CUR TIME button on bObi's remote.

2

The first hour digit will start flashing. Use the FWD and BACK buttons to adjust the first hour digit.

3

Press the RGHT button to move on to the next digits. Use the FWD and BACK buttons to adjust the hour and minute digits.

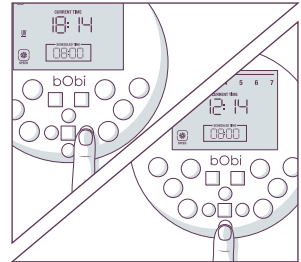
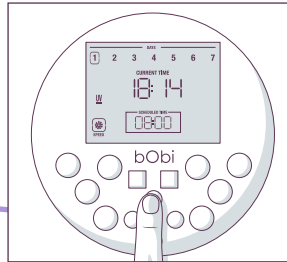
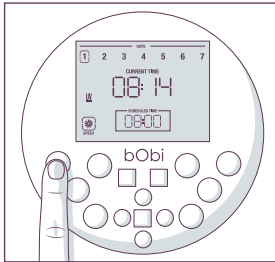

bObi will start cleaning on the scheduled time even if her dustbin or brushes need cleaning. Remember to regularly check bObi's dustbin and brushes to make sure they are clean.

4

Press the RGHT button until the frame around number 1 on top of the screen starts to flash.

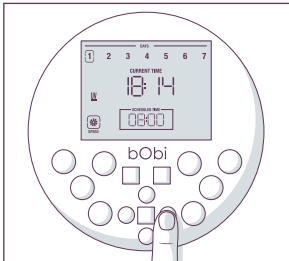

5

Press the FWD and BACK buttons to scroll through weekdays.

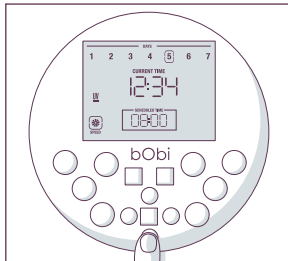

6

When you reach the current weekday, press CUR TIME again to save the day.

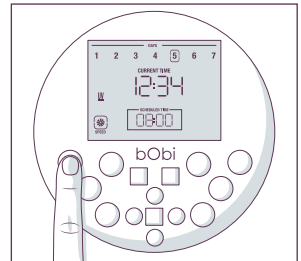

Setting a Cleaning Schedule

To set the cleaning time and days:

1

Make sure bObi's power switch is ON. Press the SCH TIME button on bObi's remote.

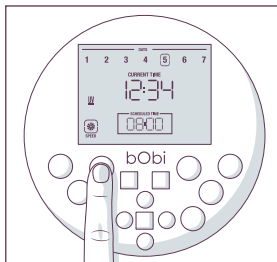

2

The first hour digit under SCHEDULE TIME will start flashing. Use the FWD and BACK buttons to adjust the first hour digit.

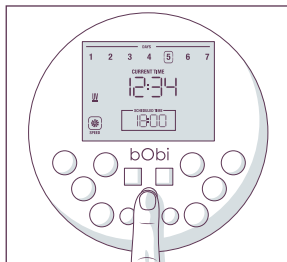

3

Press the RGHT button to move on to the next digits. Use the FWD and BACK buttons to adjust the hour and minute digits.

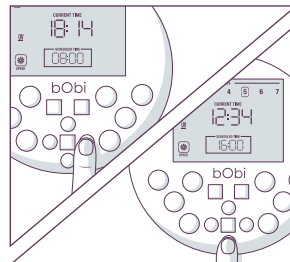

4

Press the **RGHT** button until the frame around number 1 on top of the screen starts to flash.

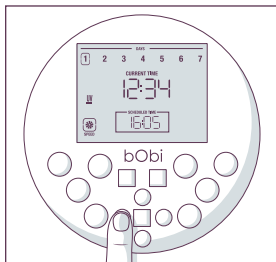

5

Press the **FWD** and **BACK** buttons to scroll through the weekdays.

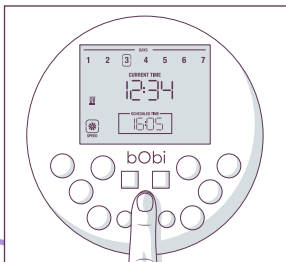

6

Press **OK** to select a day while the frame around that day is flashing. Days that are selected are underlined. Press **OK** again to deselect a day.

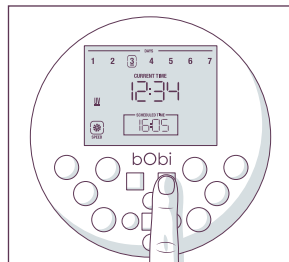

If you'd like bObi to clean every day, press the **ALL/NONE** button. Press the **ALL/NONE** button again to deselect all days.

7

Use FWD and BACK to scroll through weekdays and press OK to select or deselect cleaning for each day.

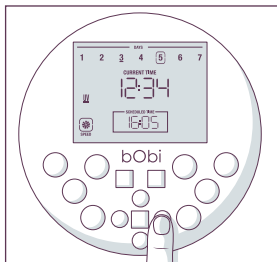

8

Press SCH TIME to save your settings.

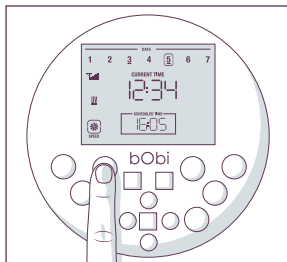

9

bObi will chirp to confirm she has saved her new schedule.

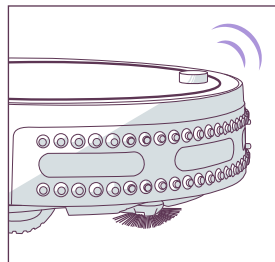

Auto-Resume

On auto-resume mode, bObi leaves her charging station EVERY TIME her battery is full to perform “back-to-back” cleaning cycles.

To enable auto-resume:

1

Make sure bObi and her remote are synced and bObi’s power switch is ON.

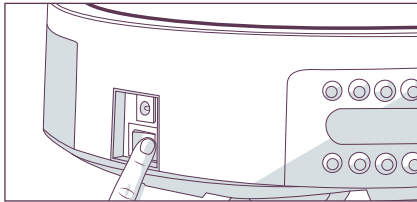

2

Press the SCH TIME on bObi’s remote. The first hour digit under SCHEDULE TIME will start flashing.

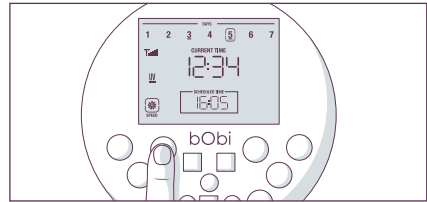

3

Press the STOP button and “FFG0”
- finish fueling and go - will appear on
the remote’s screen.

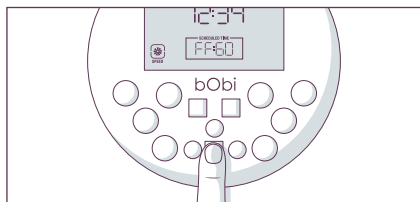

4

Press the SCH TIME button again to
save your settings.

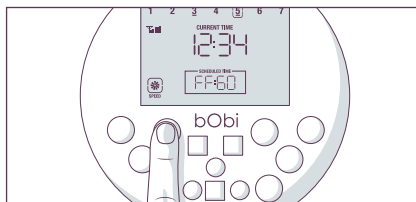

To disable auto-resume:

1

Press the SCH TIME button on the remote.

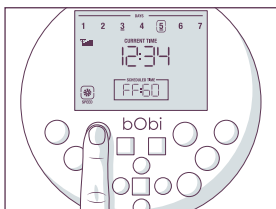

2

Press the STOP button and "FFG0" will reset to the last saved time.

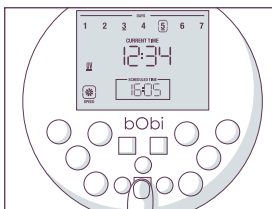

3

Press the SCH TIME button again to save your settings.

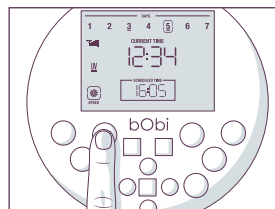

Parts & Maintenance

Mini Mop

bObi comes with a mini-mop attachment and 2 microfiber mopping cloths, which can be used dry or damp. bObi's mini-mop can be used to remove small stains from hard floors such as tile, laminates, and hardwood.

To use bObi's mop:

1

Align the two prongs of the mini-mop attachment with their notches on the underside of bObi's dustbin.

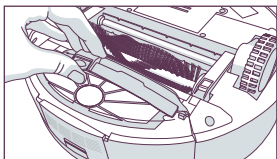

2

Hold the attachment perpendicular to bObi and press down gently until the attachment snaps into place.

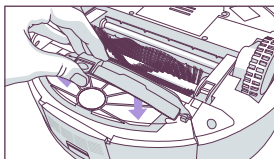

3

Lay the attachment flat along bObi's underside and lock it in place.

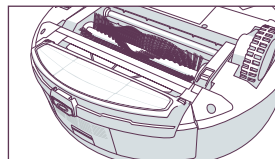

To detach bObi's mop:

1

Grip the button on the back of the mop attachment and pull up to unlock.

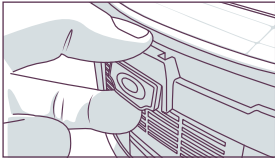

2

Lift the attachment until it is perpendicular to bObi, then pull up to detach.

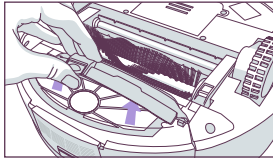

3

Remove the mopping cloth from the mini-mop attachment and wash as needed.

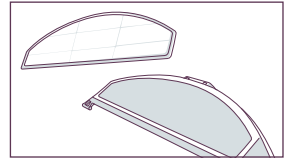

Remove the mini-mop attachment when bObi cleans rugs and carpets.

Dustbin

To empty the dustbin:

1

Hold down the eject button on the back of the dustbin.

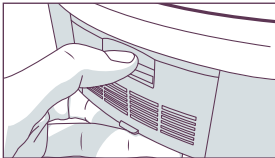

2

Pull the dustbin out.

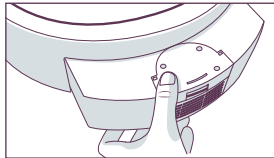

3

Pull up the two color clips on either side of the dustbin with both hands. This will release the gate.

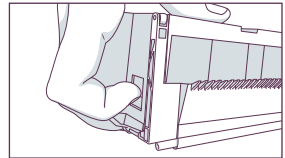

Use the cleaning tool to remove remaining dirt and dust from the dustbin.

Do not remove the dustbin while bObi is upside down.

The filter captures small debris, and prevents them from escaping back into the air.

To remove and clean the filter:

1

Eject the dustbin and release the gate.

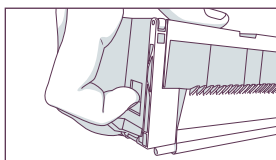

2

Flip the dustbin upside-down and open the clear filter cover.

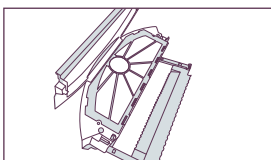

3

Remove the filter and dust it off using bObi's cleaning tool.

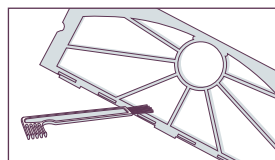

It is recommended that you change bObi's filter every 6 months if you are using her regularly.

Washing the Dustbin

One of bObi's best features is her washable dustbin. To wash the dustbin, first remove the filter and the vacuum motor.

To remove the vacuum motor:

1

Eject the dustbin, and remove the HEPA filter.

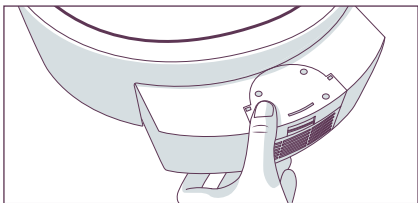

2

Press the button on top of the dustbin.

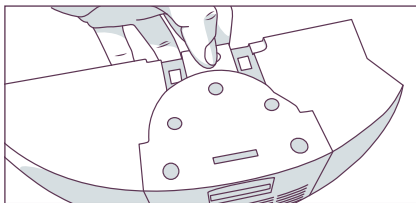

With the motor and filter removed, the dustbin may be washed with water.

DO NOT wash or wet
the vacuum motor.

To reinstall the dustbin:

1

Replace the filter and vacuum motor.

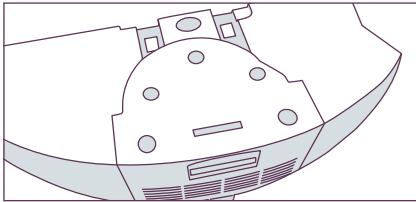

2

Slide the dustbin into bObi until it locks properly.

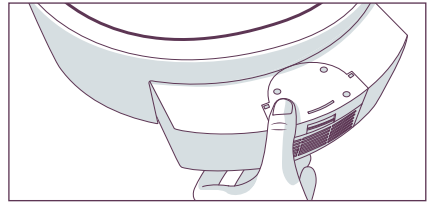

Main Brushes

bObi uses a dual brush cleaning system. It is recommended that you open and clean bObi's main brushes after every 2-3 cleaning tasks.

To open and clean the brushes:

1

Flip bObi over and press the latch on the side of the main brushes.

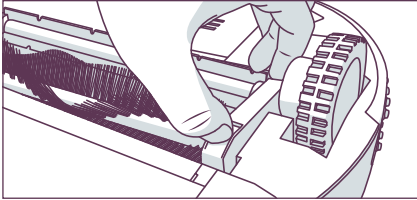

2

Lift the locking bar up and remove the main brushes.

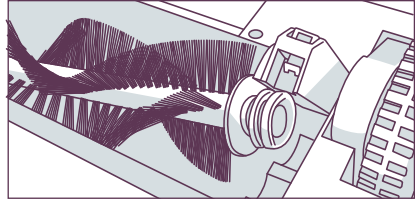

3

Use the cleaning tool to remove debris from the ends of the brush as well as the brush compartment.

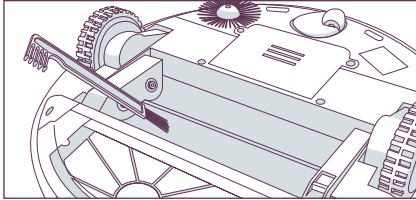

4

You may use a pair of scissors to cut away any hair or threads wrapped around the brush, or a pair of tweezers to remove congestion from the notches where the main brush is held.



5

Remove and clean the rubber brush ends. Make sure the metal cores remain in place before replacing the brush ends.

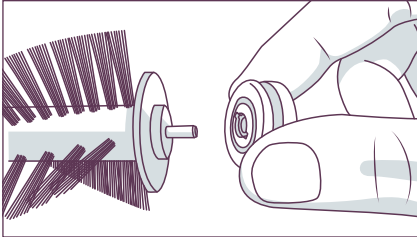

6

Starting with the rubber brush, replace the brushes. Insert the socket ends first, and lower the rubber ends into place under the latch bar.

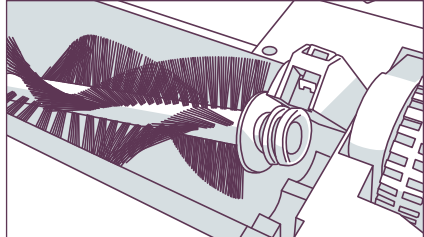

7

Lower the locking bar until it clicks and locks into place.

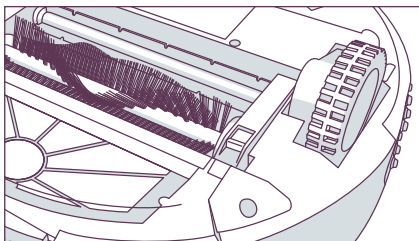

Side Brush

bObi uses a side brush to clean along corners and walls. Dirt and dust trapped around the brush can hinder its ability to move freely and reduce bObi's efficiency.

To clean the side brush:

1

Remove the side brush using a Phillips head screwdriver.

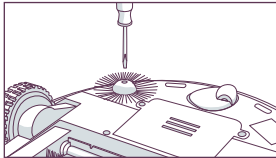

2

Use the cleaning tool to brush off hair tangled around the side brush, as well as the socket where the side brush is held.

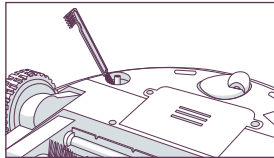

3

Replace the side brush and retighten the screw.

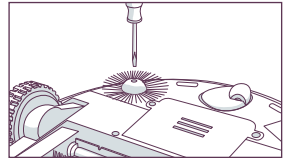

UV Light

bObi's UV light is activated by default. The UV light is only visible while she is cleaning.

To toggle the UV light ON or OFF:

- While bObi is cleaning, press the UV button on the remote.

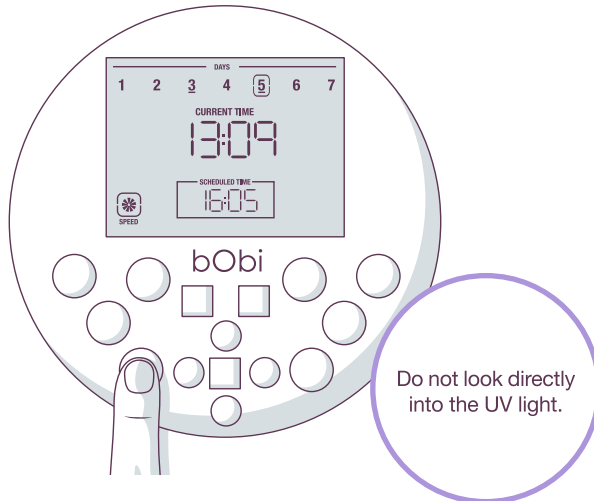

Front Wheel

To remove and clean the wheel:

1

Using a flat head screwdriver for leverage, pop the wheel out of its socket.

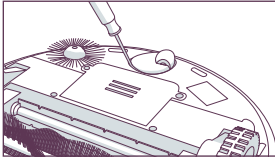

2

Clean the wheel and the socket where it is held.

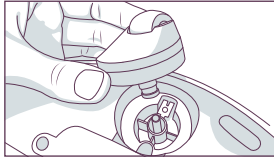

3

Replace the wheel and push it down until it locks into place.

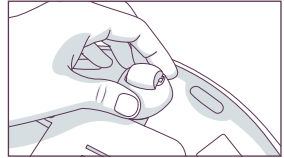

Dirt and dust on bObi's wall and edge sensors can reduce her performance. Regularly cleaning these sensors ensures that bObi keeps working at her best.

To clean bObi's sensors:

- Wipe the wall and edge sensors using a cloth slightly dampened with cold water or rubbing alcohol.

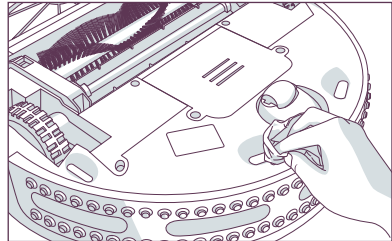
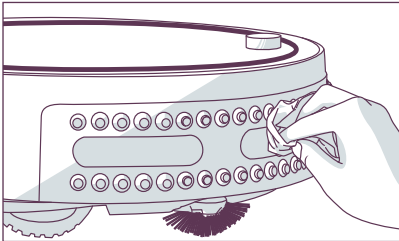

Blindfold Stickers

Dark-colored carpet and certain floor patterns may seem like edges to bObi's edge sensors. If bObi displays Error Code 01 (Er 01) on her remote while working on your carpet, you may need to "blindfold" her using the blindfold stickers that came in her box.

To blindfold bObi:

- Peel off the backs of each blindfold sticker and place one onto each of bObi's 4 edge sensors. Make sure each sensor is completely covered.
- Remember, while bObi is blindfolded, she will not be able to detect stairs or edges!

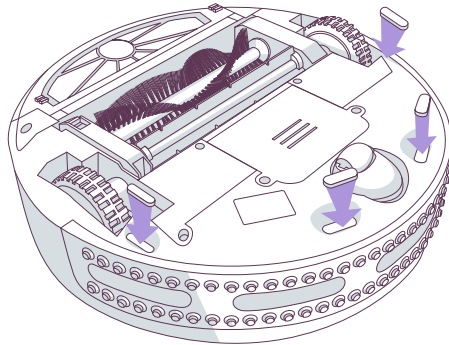

Storing

bObi should not be left unused with her power switch ON for more than 5 days. If you are not using bObi for an extended period of time, switch her OFF. Then, unplug the charging station, remove bObi's battery, and store everything in a dry place at room temperature.

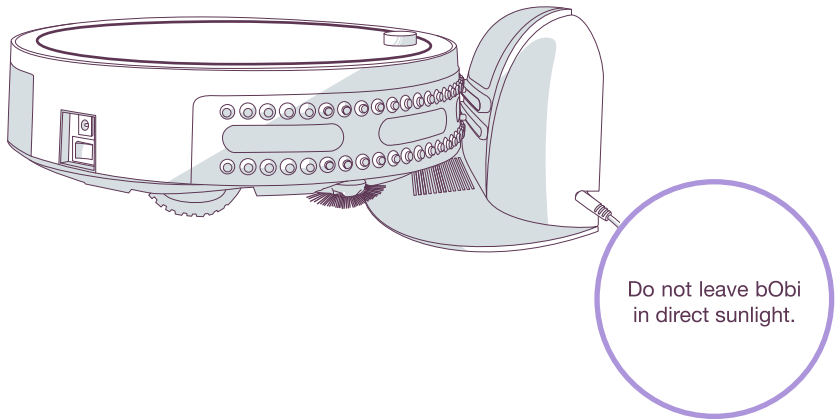

Troubleshooting & Checkup Test

Troubleshooting

When bObi faces an uncomfortable situation, she stops and displays ER and a two-digit number on her remote. Each number corresponds to a certain issue bObi is having.

If after attempting the suggested solutions bObi's problem persists, you may want to perform a home checkup test (see page 80). You may also contact our customer care center at support@bobsweep.com or call 1-888-549-8847.

Visit owners.bobsweep.com or download the [bObsweep App](#) on your iOS or Android device for handy video guides, or scan this QR code:

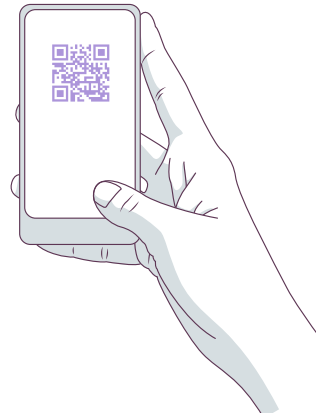

Error Code 01 (Er 01): Edge Sensors

bObi's four, oval-shaped edge sensors are located on her underside, near her bumper.

What to do:

- Clean the edge sensors using a clean, dry cloth or compressed air.
- If bObi displays Error Code 01 while working on dark-colored or patterned flooring, you may need to blindfold her (see page 70).

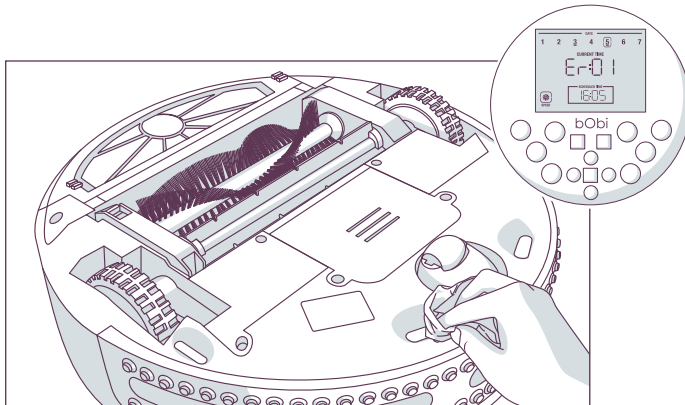

Error Code 02 (Er 02): Brushes

What to do:

- Remove bObi's main and side brushes, and clean them thoroughly from end to end (see page 62). You may use a pair of scissors to cut hair or thread wrapped around bObi's brushes, or a pair of tweezers to remove congestion from the ends of the brushes.
- If bObi displays Error Code 02 while cleaning on a shag carpet or rug, you may remove her main brushes and allow her to clean without them, but she will not clean as effectively.

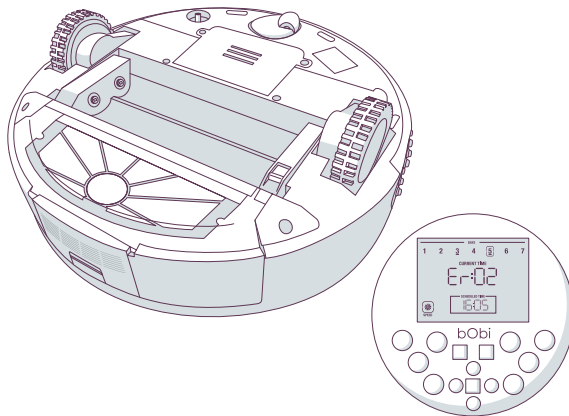

Error Code 03 (Er 03): Power System

What to do:

- Check bObi's battery connection. Open the battery compartment and unplug the battery. Wait 30 seconds, then reinstall the battery.
- Plug the charging adapter directly into the inlet above bObi's power switch. Let her charge for at least 8 hours.

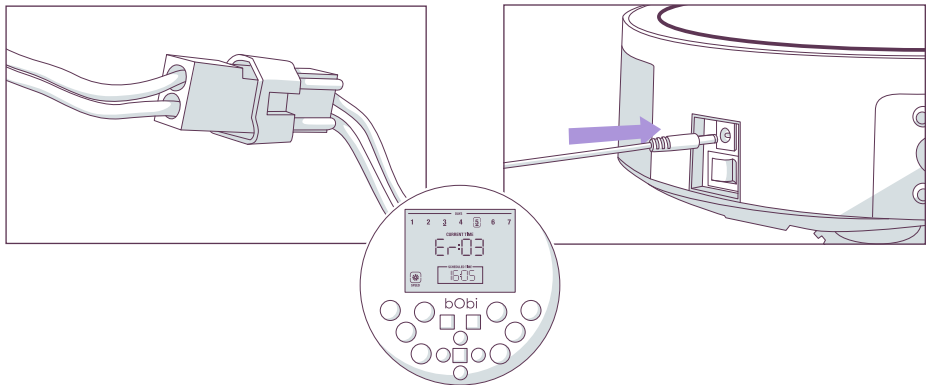

Error Code 04 (Er 04): Left/Right Wheels

What to do:

- Check bObi's left and right wheels for jamming.
- Remove the two screws around each wheel and use compressed air to remove debris inside the brush compartments.

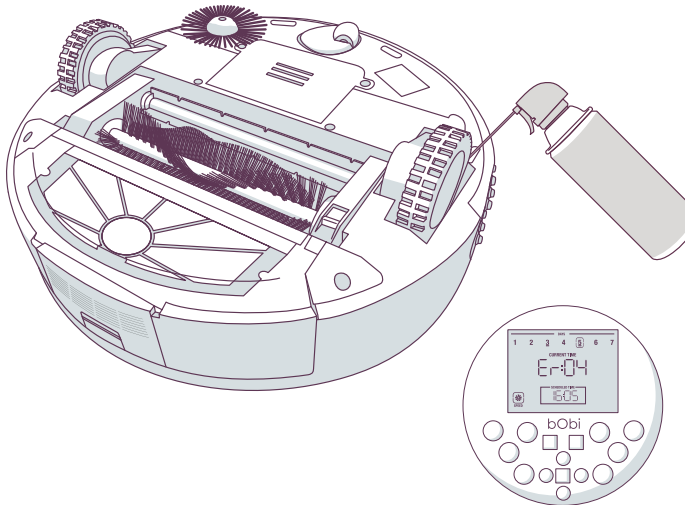

Error Code 05 (Er 05): Dustbin

What to do:

- Remove the dustbin and empty it. Turn the dustbin around and gently wipe the metal plates on its bottom with a soft, dry cloth.
- Look at where the dustbin connects to bObi's body. Under the red plastic casing is the dustbin's contact points. Make sure they spring freely and are not stuck or bent.
- If one or both of the contact points are stuck, use a screwdriver to gently pull them out.
- Carefully reinstall the dustbin while bObi is in the upright position, so that the dustbin securely locks.

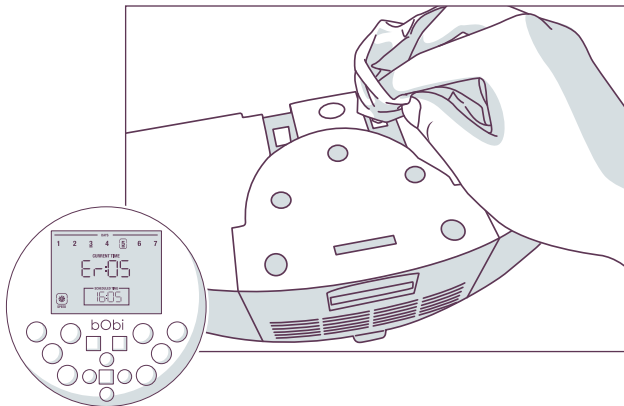

Home Checkup Test

If bObi is not performing as well as she used to, you can diagnose the problem with a simple home checkup test.

If bObi fails any part of the checkup test, she may need a replacement part. In this case, please call our customer care center at [1-888-549-8847](tel:1-888-549-8847) for toll-free support in the US and Canada, or email us at support@bobsweep.com. Our business hours are Monday – Friday 9 am – 5 pm, PST.

To put bObi in checkup mode:

1

Flip bObi's power switch OFF.

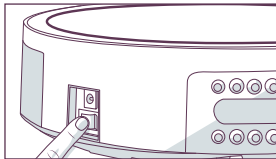

2

Press and hold the OK button on the remote while switching bObi's power switch ON. Continue holding the OK button.

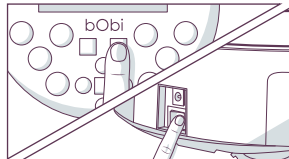

3

bObi's touchscreen buttons will start flashing. While still holding down the OK button on the remote, simultaneously press the WAFFLE and JUICE buttons on bObi's cover.

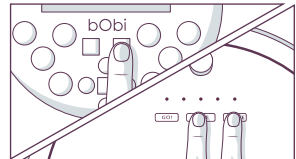

bObi will beep twice to confirm that she is in checkup mode. You may now release the OK button on the remote. The current and scheduled times should clear from the remote, and GO!, JUICE, and WAFFLE should all remain lit on bObi's cover. The 5 lights above the touchscreen buttons should cycle sequentially.

bObi is now in checkup mode.

Note: The X's are just a placeholder. Four digit number will vary.

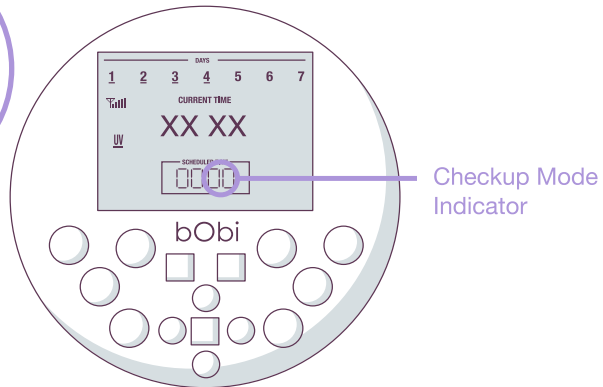

- Press RGHT on bObi's remote to cycle through each step of the checkup test.
- Press LEFT to alternate between subsections of each step. The checkup mode indicator shows which step of the test bObi is in.

Step 1: Edge and Wheel Sensors

The checkup mode indicator should read 0000. Numbers 1 – 4 at the top of the remote represent bObi's 4 edge sensors, and the numbers 5 and 6 represent the 2 ground sensors inside bObi's left and right wheels.

Remove bObi's side brush before testing her edge sensors.

1

With bObi on the floor, numbers 1 – 4 should be underlined to show that bObi's edge sensors are working.

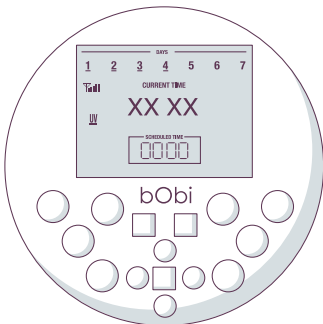

2

Lift bObi about 6 inches (15 cm) off the ground. The 4 lines under numbers 1 – 4 should disappear, and numbers 5 and 6 should be underlined.

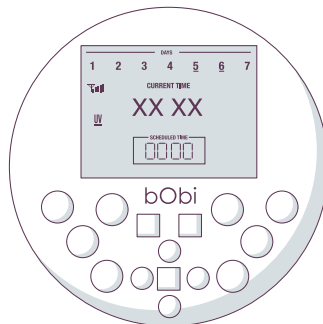

Step 2: Firmware Version

While in mode 0000, press LEFT on the remote. The checkup mode indicator should read 0001. The main 4-digit number in the center of the screen indicates the firmware version of your bObi.

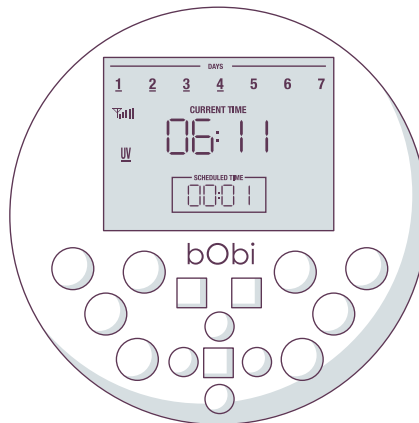

Step 3: Battery

While in mode 0001, press LEFT on the remote. The checkup mode indicator should read 0002. The main 4-digit number in the center of the screen indicates the voltage of bObi's battery in millivolts (mv).

A fully charged battery should have a voltage between 1300 and 1600 mv. If the voltage is below 1400 mv, charge bObi for at least 8 hours and repeat this step. bObi should not be tested while she is charging.

If bObi is fully charged and the voltage is 0000 mv, bObi's battery is disconnected. Open the battery compartment and check the battery connection.

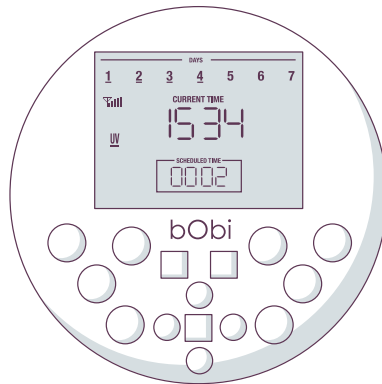

Step 4: Wall Sensors

While in mode 0002, press **RGHT** on the remote. The checkup mode indicator should read 0100. Ignore the main 4-digit number in the center of the screen.

Use a thick, flat, and white surface to imitate a wall in front of bObi. Drag the imitation wall from the left side of bObi's front around to the right side. Numbers 1 – 5 at the top of the remote will become underlined one-by-one as you do this.

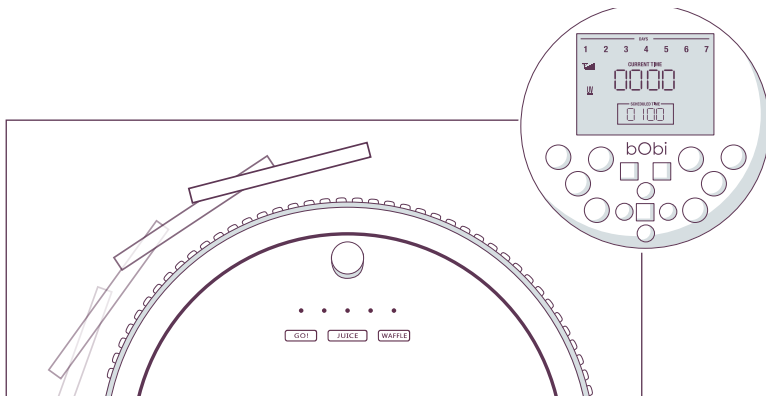

Step 4-2: Touch Sensors

Do not press any additional buttons. Ignore the numbers on the main 4-digit number in the center of the screen. 80 touch sensors surround bObi's front. While in mode 0100, press on any of the touch sensors on the left side of the bumper and the number 6 should be underlined. Do the same to the right side and the number 7 should be underlined.

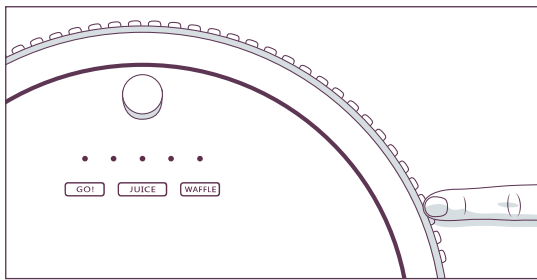
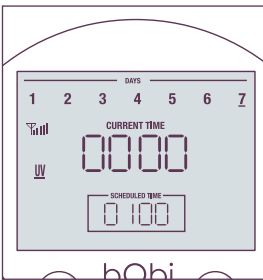
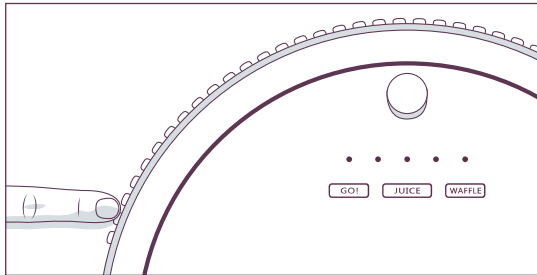
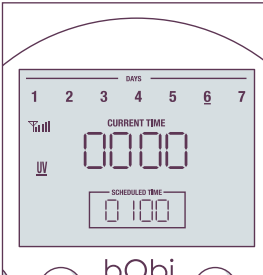

Step 5: Usage Counter and bLock™

Press **RGHT** on the remote while in checkup mode 0100. Mode will change to 0200. In this mode, the main 4-digit number in the center of the remote indicates the number of times bObi's battery has been used.

In this mode (0200), bring bObi near her bLock™. Make sure the front of the bLock™ is facing bObi. Turn the bLock™ ON. Number 5 on the top of the remote will be underlined to indicate that bObi and bLock™ can communicate with each other. If number 5 is not underlined, sync bObi and bLock™ (page 33) and repeat this step.

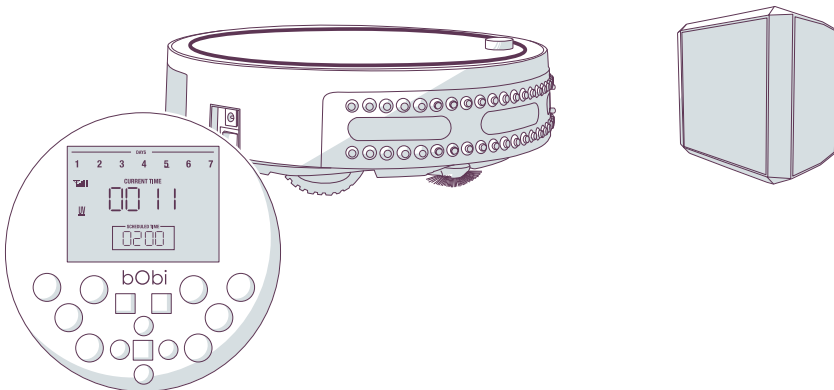

Step 6: Left and Right Wheels, Brushes, and Vacuum Motor

Flip bObi over onto a flat surface.

While in mode 0200, press RGHT on the remote. The checkup mode indicator should read 0300. As soon as bObi enters this mode, her wheels should drive forward, her brushes should rotate, and her vacuum motor should run. Numbers 1 and 3 at the top of the remote should be underlined, indicating that the left and right wheels' speed sensors are working.

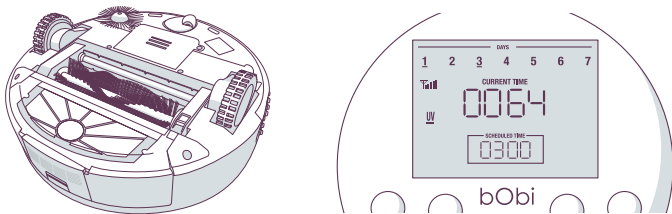

Left Wheel: While in mode 0300, the 4-digit number in the center of screen indicates the current of bObi's left wheel. Normal current ranges between 0020 and 0110.

Right Wheel: Press LEFT on the remote to enter checkup mode 0301. The main 4-digit number in the center of screen indicates the current of bObi's right wheel. Normal current ranges between 0020 and 0110.

Main Brush: Press LEFT on the remote again to enter checkup mode 0302. The main 4-digit number in the center of screen indicates the current of bObi's main brush. Normal current for the brushes is below 0280.

Vacuum Motor: Press LEFT on the remote again to enter checkup mode 0303. The main 4-digit number in the middle of screen indicates the current of the vacuum motor. Standard current ranges between 0160 and 0220.

Step 7: Charging Station

While in mode 0303, press RGHT on the remote. The checkup mode indicator should read 0400.

The main 4-digit number in center of the screen should read 0000.

Place bObi on her charging station with the nodes on her front resting against the plates on her station. The main 4-digit number in the center of the screen will now indicate the current bObi is receiving from the station. If bObi is not fully charged, the test mode indicator should read between 0400 and 0800. A number between 0050 and 0100 means bObi is fully charged and receiving less energy from her station. If the remote displays 0000 while bObi is on her station, then she is not connecting with it properly.

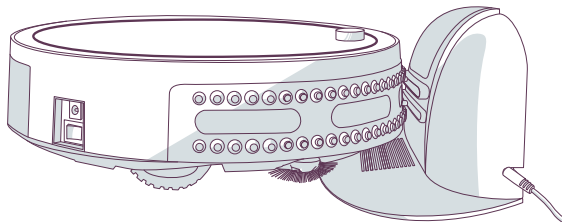
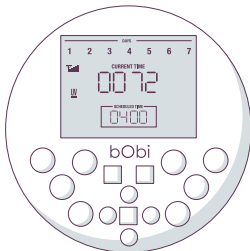

Exit Checkup Mode

To exit checkup mode, flip bObi's power switch OFF at any time. When you switch bObi back ON, bObi will return to her normal working mode, and the remote will show the current time and scheduled time.

If everything responds properly, bObi's internal parts are working correctly. If you have any questions, contact our helpful team at support@bobsweep.com for further assistance. Or, call us toll-free at **1-888-549-8847**. Our hours are Monday – Friday 9 am – 5 pm, PST.

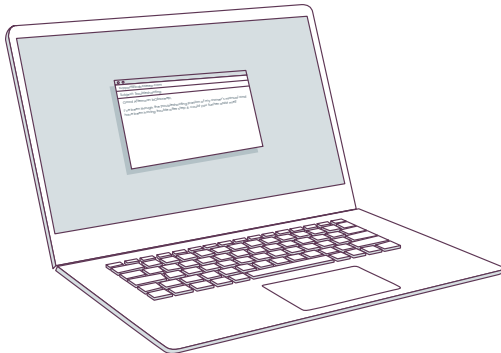

bObi's Cleaning Behavior

bObi's cleaning pattern may look quite different from the way a human would clean. She may travel in a straight line, follow along walls, or zigzag across a small area. Sometimes she may seem to be ignoring some spaces or spending too much time on others — but don't worry! Rest assured, bObi will efficiently clean your home within the course of a full cycle — just check bObi's dustbin for the evidence!

It is best to let bObi work in her own way, even if her movements appear odd. Picking her up and moving her around may confuse her and disrupt her cycle.

If you would like bObi to avoid a certain area, you may create an invisible, 10 foot barrier with bObi bLOck™. Or, if you would like to control bObi's movements manually, feel free to use the navigation buttons on her remote.

Warranty Information

Every bObi Pet purchased from an authorized seller includes a 2-year limited warranty, 5 years of subsidized visits to the bObsweep hospital, and a lifetime of customer support. The warranty covers the battery and all labor and parts, except consumables like brushes, filters, and mopping cloths. Postal charges are also not covered by the warranty.

To purchase additional coverage plans, go to owners.bobsweep.com, click on bObi Pet, and find coverage plans.

Even after bObi's 2-year warranty is over, replacement parts and visits to the bObsweep hospital are subsidized between 25% - 50% for 5 years from the date she was first purchased.

To activate bObi's warranty, keep your original receipt and register her online at bobsweep.com/warranties/registerbobsweep.

1. Where can I find bObi Pet's how-to videos?

bObi Pet's how-to videos can be found at bObi Pet's owners' corner at owners.bobsweep.com.

2. How long should bObi's battery last?

The exact time depends on the age of the battery and the type of surface bObi is cleaning. Generally, the smoother the surface (e.g. hardwood or tile), the longer the battery will last. When bObi is fully charged, she works on average 60 minutes.

3. How often should I empty the dustbin?

It is recommended that you empty bObi's dustbin after one or two cleaning cycles, but that largely depends on the volume of cleaning that she does.

4. How often do I need to change bObi's HEPA filter?

It is recommended that you clean bObi's HEPA filter every week, and replace the filter every 6 months.

5. How often should I clean bObi's brushes?

Since the brushes do a lot of work picking up hair and larger debris, it is recommended that you clean them every 1 to 4 uses (see page 62).

However, if you clean them more frequently, bObi will be able to store more dirt in her dustbin, rather than on her brushes. If you notice a thick covering of hair, dust, and debris on her brushes, remove and clean them. This ensures they stay in good condition for a long time. Remember to also clean the main brush compartment.

6. My bObi won't turn on no matter what I do.

If bObi does not start after flipping her power switch ON, her battery has likely drained too low to operate. To recharge, place her on her charging station with the metal nodes on her front resting against the plates on her station. Alternatively, you can unplug the adapter from the charging station and plug it directly into the inlet above bObi's power switch. When bObi is charging, the center light on her cover will blink. Let bObi recharge fully before using again.

7. Why is my bObi beeping?

bObi beeps when she encounters problems cleaning and needs assistance. In addition to beeping, she will display an Error Code (Er) on her remote, which lets you know why she has stopped (see page 75).

8. bObi is having trouble finding her charging station. Where is the best place to put the station?

bObi will find her station more easily if you place it in a central location with plenty of space around it, so that she may detect it from afar. To facilitate bObi's docking, place the charging station against a wall on a flat surface (like hardwood or tile flooring) instead of carpet. To increase bObi's chance of finding her station, place the station in a spot where bObi has a higher chance of passing through.

9. I am having problems removing bObi's brushes.

If the main or side brushes are difficult to remove, it is likely because hair, string, or other debris have been caught in them and are clogging the areas where they attach to bObi. You can use scissors to cut the hair wrapped around either brush, until you are able to remove it.

10. bObi is getting stuck under some of my furniture or traveling into areas with wires that tangle up the brush. How can I stop her from going into these areas?

If bObi maneuvers under a piece of furniture and there is only one open entrance, she may need a few minutes to figure out how to escape on her own. You will not need to assist her when this happens, unless bObi stops cleaning completely and starts beeping.

If you would like bObi to avoid a certain area, such as an area with wires, you may use bLock™ to create a digital barrier.

11. Why does bObi start cleaning even though I did not tell her to clean?

bObi will start up on her own when she is 1) scheduled to clean, or 2) when she is on auto-resume mode.

First, make sure the “Current time and day” is set correctly on bObi’s remote. Remember, bObi works on a 24-hour clock. If the current time and date is incorrect, then bObi’s cleaning schedule will be out of sync. Consult the Scheduling section of this manual (page 36) for detailed instructions on how to set bObi’s cleaning schedule.

When bObi is on auto-resume mode, she displays “FFGO” on her remote, below “Scheduled Cleaning.” On auto-resume, bObi automatically begins cleaning after she has fully charged. To disable auto-resume, press the SET CLEANING SCHEDULE button on bObi’s remote. Then press STOP. “FFGO” will reset to the last time saved. Press SET CLEANING SCHEDULE again to save your settings.

12. When is a good time to use the Waffle function?

The Waffle function is best for cleaning a small spill of dry substances. It is a great way to target only one area that has become dirty, such as a spill that must be swept or mopped in an otherwise clean area.

13. My bObi is stopping and showing an Error Code on the remote's screen. How can I fix this?

To understand bObi's language, consult the Troubleshooting section of this manual for the cause of the problem as well as the solution.

14. Where can I buy spare parts?

Extra parts are available for purchase on our owners' website, owners.bobsweep.com. With bObi's modular design and our how-to videos, you can change each individual part easily if it gets old or worn out.

15. I have a question and need to contact bObsweep's support team.

Call us toll free at [1-888-549-8847](tel:1-888-549-8847) for support in the US and Canada, or email us at support@bobsweep.com. Our hours are Monday – Friday 9 am – 5 pm, PST.

To find bObi's how-to videos, repair videos, troubleshooting videos, and to connect with your extended bObsweep family members, visit bObi Pet's owners' corner at owners.bobsweep.com or download the [bObsweep App](#) on your iOS or Android device.

End User License Agreement

IMPORTANT - READ BEFORE USING. Do not use the robot ("Bobsweep") accompanying this license agreement ("Agreement") until you have carefully read and agreed to the following terms and conditions.

By using the Bobsweep, you agree to the terms of this End User License Agreement ("EULA") and any amendment or addenda accompanying this Agreement. If you do not agree to the terms of this EULA, you may not use the Bobsweep. The Bobsweep contains an electronic and software interface that allows you to control or modify its behavior, and remotely monitor its sensors.

THIS IS A LEGAL AGREEMENT. BY ACCESSING AND USING THE PRODUCT AND PRODUCT SOFTWARE, YOU ARE ACCEPTING AND AGREEING TO THIS EULA ON BEHALF OF YOURSELF OR THE ENTITY YOU REPRESENT IN CONNECTION WITH THE ACCESS. YOU REPRESENT AND WARRANT THAT YOU HAVE THE RIGHT, AUTHORITY, AND CAPACITY TO ACCEPT AND AGREE TO THIS EULA ON BEHALF OF YOURSELF OR THE ENTITY YOU REPRESENT. YOU REPRESENT THAT YOU ARE OF SUFFICIENT LEGAL AGE IN YOUR JURISDICTION OR RESIDENCE TO USE OR ACCESS THE PRODUCT SOFTWARE AND TO ENTER INTO THIS EULA. IF YOU DO NOT AGREE WITH ANY OF THE PROVISIONS OF THESE TERMS, YOU SHOULD CEASE USING THE PRODUCT AND PRODUCT SOFTWARE.

Terms and Conditions

LICENSE: Subject to all of the terms of this Agreement, Bobsweep Inc. ("Bobsweep") grants to you one (1) revocable, royalty-free, personal, non-exclusive, nontransferable, non-assignable, non-commercial intellectual property license to use the Bobsweep software contained on the Bobsweep, including the protocol for communicating with the Bobsweep software contained on the Bobsweep ("Bobsweep Software"), to use the Bobsweep.

NONCOMMERCIAL LICENSE: You may use the Bobsweep Software and the Bobsweep only for personal, noncommercial, educational, and research purposes. The Bobsweep Software and the Bobsweep may not be used for any other purpose, whether "for profit" or "not for profit." Any work performed or produced using the Bobsweep, including Your Software, cannot be performed or produced for the benefit of other parties for a fee, compensation, or any other reimbursement or remuneration. A separate license is required for each additional use and/or individual user in all other cases. If you are an entity, Bobsweep grants you the right to designate one individual within your organization to have the sole right to use the Bobsweep Software and the Bobsweep in the manner provided above.

RESTRICTIONS: You agree not to: (i) use or copy the Bobsweep Software or the Bobsweep except as provided in this Agreement; (ii) rent or lease the Bobsweep Software or the Bobsweep to any third party; (iii) assign this Agreement or transfer the Bobsweep Software or the Bobsweep except as provided in this Agreement; (iv) modify, adapt, or translate the Bobsweep Software or the Bobsweep in whole or in part except as expressly provided in this Agreement; (v) reverse engineer, reverse compile, or disassemble the Bobsweep Software or the Bobsweep; or (vi) distribute, sublicense or transfer the source code form of Your Software and derivatives thereof to any third party except as provided in this Agreement.

YOUR SOFTWARE : Use and distribution of any software that you create for your Bobsweep ("Your Software") is also subject to the following limitations: You (i) shall be solely responsible for any update or support obligation or other liability which may arise from your use or distribution, (ii) shall not make any statement that Your Software is "certified," or that its performance is guaranteed, by Bobsweep, (iii) shall not use Bobsweep's name or trademarks, (iv) shall prohibit disassembly and reverse engineering of the Bobsweep Software and the Bobsweep, (v) shall not publish reviews of Bobsweep products designated as beta without written permission from Bobsweep, and (vi) shall indemnify, hold harmless, and defend Bobsweep and its suppliers from and against any claims or lawsuits, including attorney's fees, that arise or result from Your Software, including your use and your distribution. **TITLE:** Title to the Bobsweep Software remains with Bobsweep or its suppliers. The Bobsweep Software is licensed, not sold. Except as expressly provided herein, Bobsweep does not grant any express or implied right to you under Bobsweep patents, copyrights, trademarks, or trade secret information. You will not remove any copyright or patent notice from the Bobsweep Software or the Bobsweep. **ONE-TIME TRANSFER:** The initial user of the Bobsweep Software and the Bobsweep may make a one-time permanent transfer of this Agreement, the Bobsweep Software, and the Bobsweep to another end user, provided that the initial user retains no copies of the Bobsweep Software and the Bobsweep. This transfer must include the Bobsweep Software, the Bobsweep, and all of the materials accompanying the Bobsweep (including all component parts and printed materials, any upgrades, and this End User License Agreement document). The transfer may not be an indirect transfer, such as a consignment. Prior to the transfer, the end user receiving the Bobsweep Software and the Bobsweep must agree to all the terms of this Agreement. **NO WARRANTY AND LIMITED REPLACEMENT:** EXCEPT AS STATED IN THE LIMITED WARRANTY TO THE ORIGINAL PURCHASER, THE BOBSWEEP SOFTWARE AND THE BOBSWEEP ARE PROVIDED "AS IS" WITH NO WARRANTIES, EXPRESS OR IMPLIED, INCLUDING BUT NOT LIMITED TO ANY IMPLIED WARRANTY OF MERCHANTABILITY, FITNESS FOR A PARTICULAR PURPOSE, NON-INFRINGEMENT OF INTELLECTUAL PROPERTY RIGHTS, OR ANY WARRANTY OTHERWISE ARISING OUT OF ANY PROPOSAL, SPECIFICATION, OR SAMPLE. NO ORAL OR WRITTEN INFORMATION OR ADVICE GIVEN BY BOBSWEEP OR ITS AGENTS SHALL CREATE A WARRANTY. If the Bobsweep Software or the Bobsweep is found to be defective in material or workmanship under normal use for a period of one (1) year from the date of receipt, Bobsweep's entire liability and your exclusive remedy shall be the replacement of the Bobsweep Software or the Bobsweep. This offer is void if the defect results from accident, abuse, misapplication, or software that you developed for your Bobsweep. Any updates or supplements to the Bobsweep Software or the Bobsweep provided to you after the expiration of the one (1) year period are not covered by any

warranty or condition, express, implied or statutory. SOME JURISDICTIONS DO NOT ALLOW THE EXCLUSION OF IMPLIED WARRANTIES, SO THE ABOVE EXCLUSION MAY NOT APPLY TO YOU. LIMITATION OF LIABILITY: THE ABOVE REPLACEMENT PROVISION IS THE ONLY WARRANTY OF ANY KIND. BOBSWEEP OFFERS NO OTHER WARRANTY EITHER EXPRESS OR IMPLIED INCLUDING THOSE OF MERCHANTABILITY, NON INFRINGEMENT OF THIRD- PARTY INTELLECTUAL PROPERTY OR FITNESS FOR A PARTICULAR PURPOSE. NEITHER BOBSWEEP NOR ITS SUPPLIERS SHALL BE LIABLE FOR ANY DAMAGES WHATSOEVER (INCLUDING, WITHOUT LIMITATION, VICARIOUS LIABILITY, CONSEQUENTIAL DAMAGES, INCIDENTAL DAMAGES, DAMAGES FOR LOSS OF BUSINESS PROFITS, BUSINESS INTERRUPTION, LOSS OF BUSINESS INFORMATION, OR OTHER LOSS) ARISING OUT OF THE USE OF OR INABILITY TO USE THE BOBSWEEP SOFTWARE, THE BOBSWEEP, OR SOFTWARE THAT YOU DEVELOPED FOR YOUR BOBSWEEP, EVEN IF BOBSWEEP HAS BEEN ADVISED OF THE POSSIBILITY OF SUCH DAMAGES. BECAUSE SOME JURISDICTIONS PROHIBIT THE EXCLUSION OR LIMITATION OF LIABILITY FOR CONSEQUENTIAL OR INCIDENTAL DAMAGES, THE ABOVE LIMITATION MAY NOT APPLY TO YOU UNAUTHORIZED USE: THE BOBSWEEP SOFTWARE AND THE BOBSWEEP ARE NOT DESIGNED, INTENDED, OR AUTHORIZED FOR USE IN ANY AERONAUTICAL, NUCLEAR, MEDICAL, LIFE SAVING OR LIFE SUSTAINING SYSTEMS, OR FOR ANY OTHER APPLICATION IN WHICH THE USE OF THE BOBSWEEP SOFTWARE OR THE BOBSWEEP COULD CREATE A SITUATION WHERE PERSONAL INJURY OR DEATH MAY OCCUR. Should you use the Bobsweep Software or Bobsweep for any such unintended or unauthorized use, you shall indemnify and hold harmless Bobsweep and its owners, subsidiaries and allies against all claims, costs, damages, and expenses, and reasonable attorney fees arising out of, directly or indirectly, any claim of product liability, personal injury or death associated with such unintended or unauthorized use, even if such claim alleges that Bobsweep was negligent regarding the design or manufacture of the Bobsweep Software, the Bobsweep, or any part or portion thereof.

USER SUBMISSIONS: You agree that any material, information or other communication, including all data, images, sounds, text, and other things embodied therein, that you transmit or post to a Bobsweep website or provide to Bobsweep ("Communications") will be considered non-confidential. Bobsweep will have no confidentiality obligations with respect to the Communications. You agree that Bobsweep and its designees will be free to copy, modify, create derivative works, publicly display, disclose, distribute, license and sublicense through multiple tiers of distribution and licensees, incorporate and otherwise use the Communications, including derivative works thereof, for any and all commercial or non-commercial purposes without the payment of any royalty to you, and that such license will survive the termination of this Agreement.

TERMINATION: This Agreement becomes effective on the date you accept this Agreement and will continue until terminated as provided for in this Agreement. You may terminate this Agreement voluntarily at any time. Bobsweep may terminate this Agreement at any time if you are in breach of any of its terms and conditions, and may refuse to license the Bobsweep Software or the Bobsweep to you after termination. Upon termination by either party, you will immediately return to Bobsweep or destroy the Bobsweep Software and the Bobsweep and all your copies thereof, Articles 5 and 7 through 17 of this Agreement shall survive such termination. U.S. GOVERNMENT RESTRICTED RIGHTS: The Bobsweep Software and the Bobsweep are provided with "RESTRICTED RIGHTS." Use, duplication or disclosure by the Government is subject to restrictions set forth in FAR52.227-14 and DFAR252.227-7013 et seq. or its successor. Use of the Bobsweep Software or the Bobsweep by the Government constitutes acknowledgment of Bobsweep's rights in them.

NO EXPORT: You may not export the Bobsweep Software or the Bobsweep in violation of applicable export laws.

INTERPRETATION: The provisions of this Agreement are severable. If any provision of this Agreement is held to be unenforceable, such provision shall be reformed only to the extent necessary to make it enforceable. Any law or regulation which provides that the language of a contract shall be construed against the drafter shall not apply to this Agreement.

INTEGRATION: This Agreement represents the complete agreement concerning the subject matter hereof, and any and all understandings, conversations and communications, proposals, and counterproposals, oral and written (including any draft of this Agreement) are merged into and superseded by this Agreement and shall be of no force or effect, except as expressly provided herein. No such understandings, conversations, communications, proposals, counterproposals or drafts shall be referred to in any proceeding concerning this Agreement. Further, no understanding contained in this Agreement shall be modified, altered or amended, except by a writing signed by the party against whom enforcement is sought.

ARBITRATION: All disputes relating to this Agreement (excepting any dispute relating to intellectual property rights) shall be subject to and binding arbitration, with the losing party paying all costs of arbitration. Any arbitration relating to this Agreement shall be held in California, under the auspices of an arbitrator selected by Bobsweep. Any litigation relating to this Agreement shall be subject to exclusive venue and jurisdiction in the federal and state courts of California, with the losing party responsible for costs, including without limitation, court costs and reasonable attorneys fees and expenses.

APPLICABLE LAWS: Any claim arising under or relating to this Agreement shall be governed by the internal substantive laws of the Commonwealth of California, without regard to its principles of conflict of laws. The application of the United Nations Convention on Contracts for the International Sale of Goods is expressly excluded.

bObsweep

® and © bObsweep Inc. All rights reserved.