

# Bob PetHair Vision

OWNER'S MANUAL



# **Bob PetHair Vision**

OWNER'S MANUAL



# Congratulations!

Congratulations on your new intelligent floor cleaner! Bob is now at your service. To see Bob at his best, please read the Quick Start Guide and this manual thoroughly.

Welcome to the bObsweep family and Happy Sweeping!

If you have any questions or concerns, feel free to contact our helpful support team at [support@bobsweep.com](mailto:support@bobsweep.com) or 1-888-549-8847.

**Business Hours:**

- Monday – Friday, 9 a.m. – 5 p.m. Pacific Time

# Table of Contents

**1** General  
Safety Instructions  
Declaration of Conformity  
Warranty  
Contact Us

**6** bObsweep App  
My Resources  
Schedule & Control  
Shop

**9** Accessories  
Wet Mop Attachment  
NoSweep™ Stripes

**3** Anatomy  
Top View  
Bottom View  
Button Guide  
Charging Station  
Wet Mop Attachment

**7** Bob's First Clean  
Install Side Brushes  
Charge  
Download bObsweep App  
Let Bob Sweep

**11** Maintenance  
Brushes  
Sensors & Camera Window  
Front Wheel  
Battery

**5** Box Contents

**8** Troubleshooting

**17** End User  
License  
Agreement

## Important Safety Instructions

- Power Bob OFF and remove him from a power source when you are not using him and before conducting maintenance.
- Bob is not intended for use by persons (including children) with reduced physical or mental capabilities, or lack of experience and knowledge, unless under the close supervision of a person responsible for their safety.
- Leaks from the battery cells can occur under extreme usage or temperature conditions. If the liquid gets on the skin, wash quickly with water. If the liquid gets into the eyes, flush them immediately with clean water for a minimum of 10 minutes, and seek medical attention.
- Bob is composed of electronic components that in rare and unintended cases can cause hazards of heating, fire, and other malfunctions. Furthermore, because Bob is capable of autonomous movement, his use poses the risk of collision with property, pets, and persons. Unintended removal of articles — such as small valuables, jewelry, or hair of persons or pets lying on the floor — may also occur.
- If Bob or his charging station has been damaged in any way, do not operate them. Contact our support team for further assistance.
- Do not handle Bob or his charging station with wet hands; use only on dry surfaces.
- Do not pull or carry the charging station by the cord, close a door on the cord, or pull the cord around sharp edges or corners. Keep the cord away from heated surfaces. To unplug the cord, grasp the plug, not the cord.
- Do not attempt to open the charging station. Repairs on the station should only be carried out by our qualified technicians.
- With the exception of the wet mop attachment, do not immerse any part of Bob into water or other liquids.
- Do not mutilate or incinerate the battery, as it will explode at high temperatures.
- Do not use Bob outdoors.
- Do not expose Bob or his charging station to temperatures higher than 113° F (45° C), moisture, or humidity.
- Do not dispose of your battery in fire. Old batteries should be recycled safely through your local recycler.
- Do not let Bob pick up anything that is burning or smoking, such as cigarettes, matches, or hot ashes.

## Declaration of Conformity

This device complies with Part 15 of the FCC rules. Operation is subject to the following two conditions: (1) this device may not cause harmful interference, and (2) this device must accept any interference received, including interference that may cause undesired operation. The manufacturer is not responsible for any radio or TV interference caused by unauthorized modifications or changes to this equipment. Such modifications or changes could void the user's authority to operate the equipment.

This equipment has been tested and found to comply with the limits for a Class B digital device, pursuant to part 15 of the FCC Rules. These limits are designed to provide reasonable protection against harmful interference in a residential installation. This equipment generates, uses, and can radiate radio frequency energy and, if not installed and used in accordance with the instructions, may cause harmful interference to radio communications. However, there is no guarantee that interference will not occur in a particular installation. If this equipment does cause harmful interference to radio or television reception, which can be determined by turning the equipment off and on, the user is encouraged to try to correct the interference by one or more of the following measures:

- Reorient or relocate the receiving antenna.
- Increase the separation between the equipment and receiver.
- Connect the equipment to an outlet on a circuit different from that to which the receiver is connected.
- Consult the dealer or an experienced radio/TV technician for help.

## Warranty

Every Bob PetHair Vision purchased from an authorized seller comes with our warranty coverage:

- 60-Day Money Back Guarantee
- 2-Year Standard Warranty
- 5-Year Subsidized Repair Plan
- Lifetime of Customer Service

To claim your warranty, register your bot at [www.bobsweep.com/warranties](http://www.bobsweep.com/warranties).

## Contact Us

If you have any questions or concerns, please contact our helpful support team at [support@bobsweep.com](mailto:support@bobsweep.com) or 1-888-549-8847.

Business Hours:

- Monday – Friday, 9 a.m. – 5 p.m. Pacific Time

Additional troubleshooting information and how-to guides can be found on the bObsweep app and at [www.bobsweep.com/support](http://www.bobsweep.com/support).

# Anatomy

## Top View

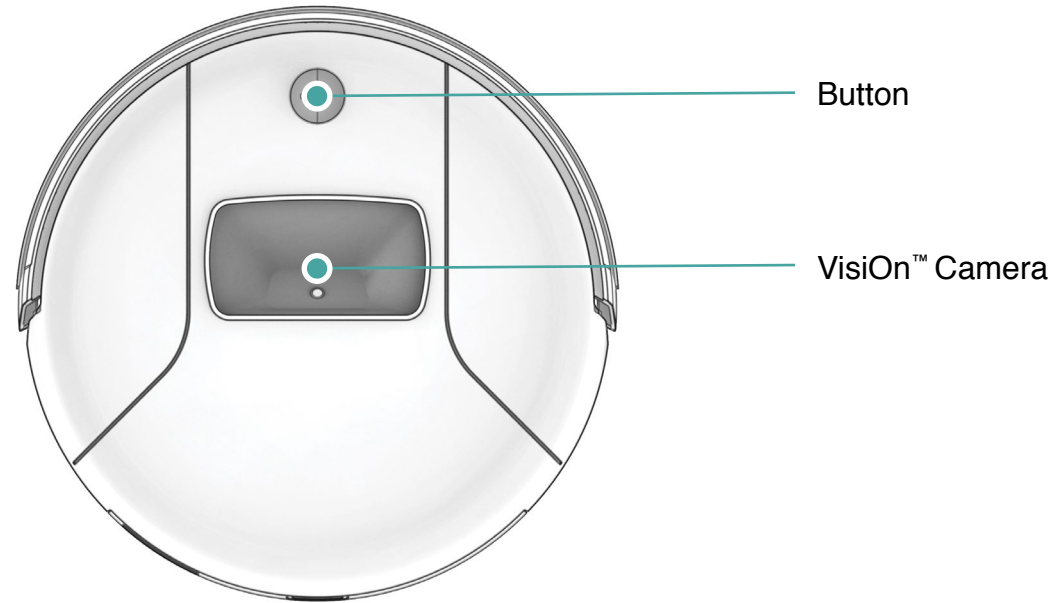

## Bottom View

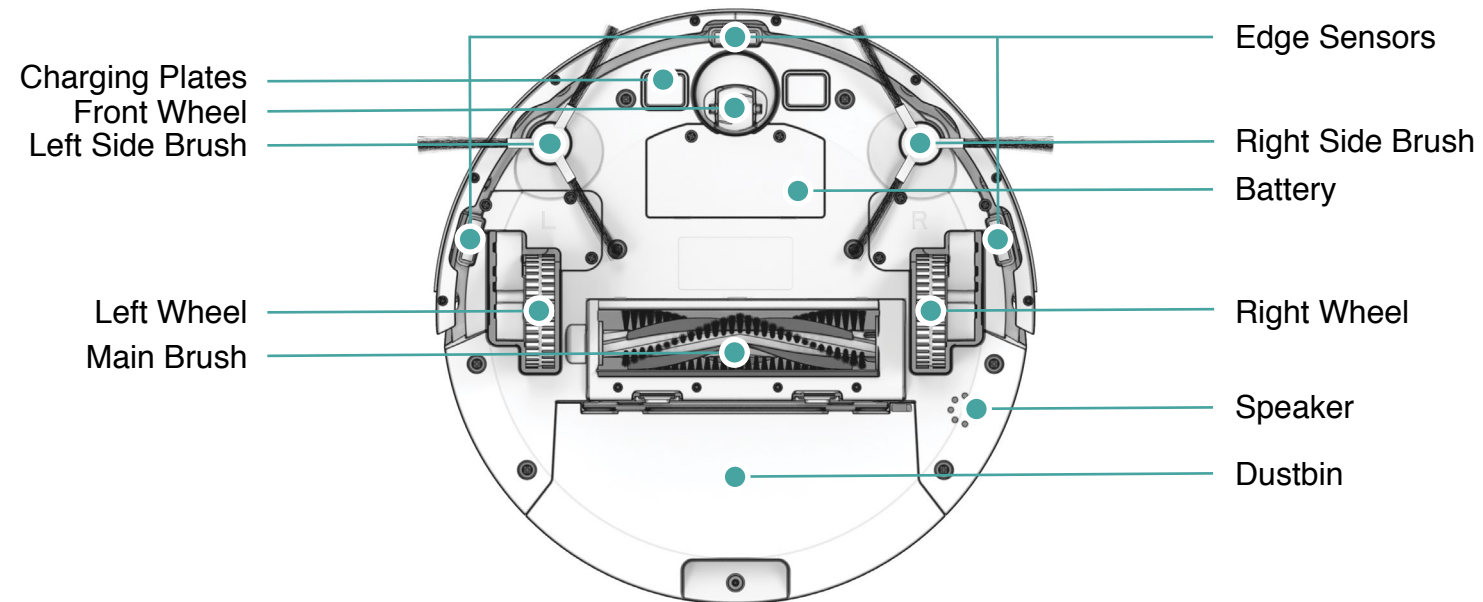

# Anatomy

## Button Guide

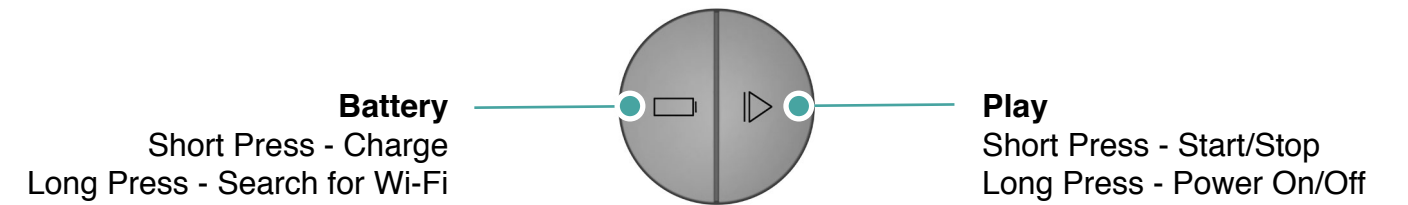

## Charging Station

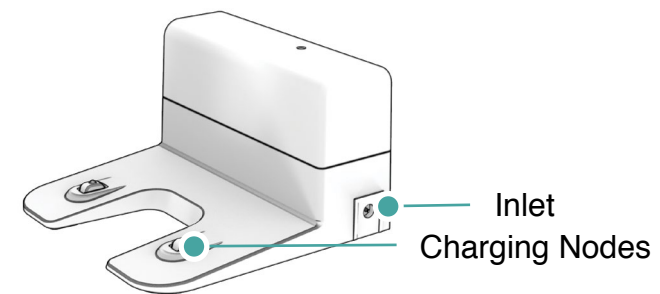

## Wet Mop Attachment\*

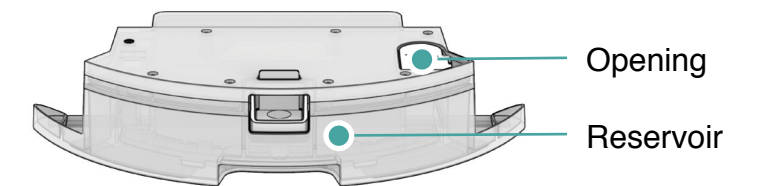

\*Sold separately. Included in accessories bundle.

# Box Contents



Bob PetHair Vision

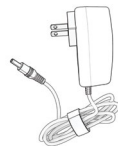

Charging Adapter



Charging Station



Cleaning Tool



Side Brushes (4)

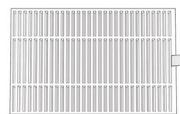

Filters (2)



Wet Mop Attachment\*



Microfiber Mopping Cloths (2)\*

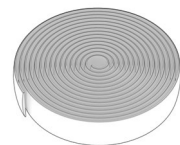

NoSweep™ Stripes\*

# bObsweep App

## My Resources

Digital versions of your Quick Start Guide and Owner's Manual are available to view on the "Home" page of the bObsweep app.

## Schedule & Control

Set Bob's cleaning schedule and send him to clean or charge on the "Sweep" page of the bObsweep app.

**Quick Tip:** To disable all audio messages, mute Bob's speaker on the "Sweep" page.

## Shop

Shop for parts and accessories on the "Shop" page of the bObsweep app.

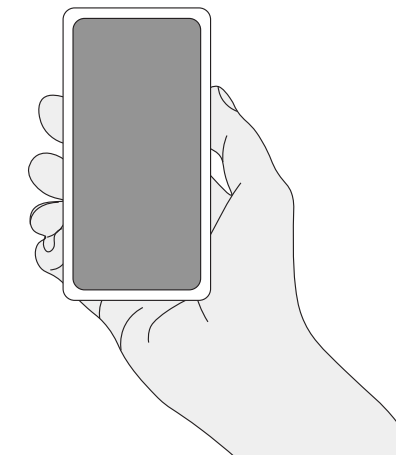

## Before Starting

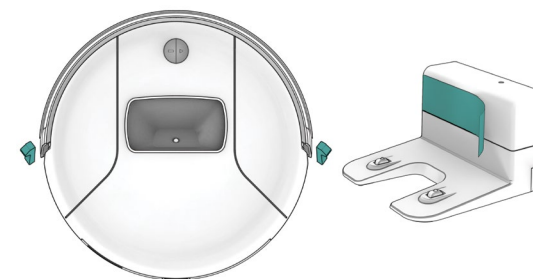

Remove the protective pieces from Bob's bumper and charging station.

## Charging Indicator

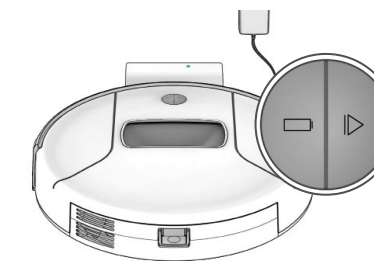

**Low Battery:** The button rapidly blinks blue.  
**Finding Station:** The button shines blue.  
**Charging:** The button slowly blinks blue.  
**Fully Charged:** Buttons shine white.

# Bob's First Clean

## 1. Install Side Brushes

Press down to lock the left (L) and right (R) side brushes onto Bob.

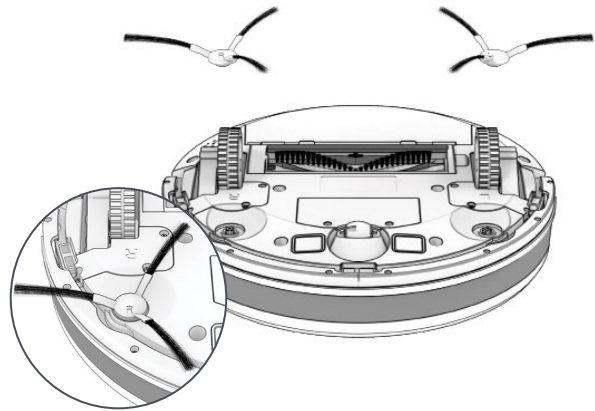

## 3. Download bObsweep App

Download the bObsweep app for your iOS or Android device. Create your account and connect your bot.

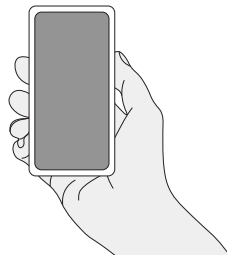

**Important Notes:** Bob always returns to his charging station after cleaning. To increase Bob's chance of finding his station, place it on a hard, flat surface with plenty of room around it.

## 2. Charge

Place Bob on his station and allow him to fully charge.

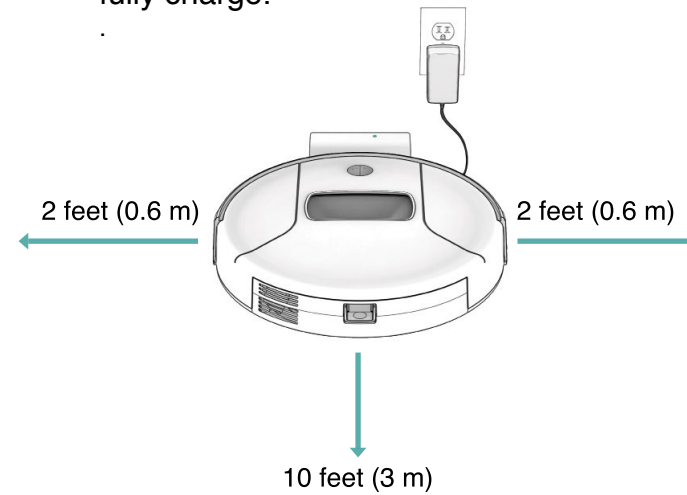

## 4. Let Bob Sweep!

When done, Bob is ready to sweep! Clear away any clutter or wires and press the play button.

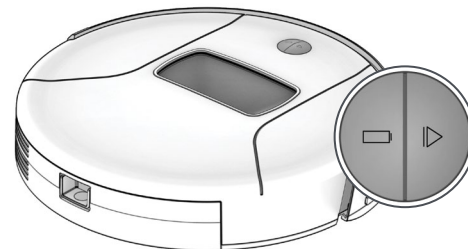

# Troubleshooting

Whenever Bob runs into trouble, he will stop and his play button will rapidly blink blue. Check the bObsweep app for further details.

Trouble	Solution
Left Wheel	Left wheel is jammed. Check for obstruction and clean.
Right Wheel	Right wheel is jammed. Check for obstruction and clean.
Off Ground	Wheels are off the ground. Place Bob back on the ground.
Main Brush	Main brush is jammed. Remove and clean.
Side Brushes	Side brushes are jammed. Remove and clean.
Bumper, Left	Left touch sensor is jammed. Check the bumper for obstruction and clean.
Bumper, Right	Right touch sensor is jammed. Check the bumper for obstruction and clean.
Edge Sensor, Left	Bob is near a cliff. Move Bob to safety.
Edge Sensor, Right	Bob is near a cliff. Move Bob to safety.
Low Battery	Low battery. Charge Bob.
Power Error	Power error. Check the battery and power connection.
Vacuum Motor	Vacuum motor is jammed. Open the filter container and remove any congestion.
Dustbin	Dustbin is disconnected. Remove, wipe the connectors, and reinsert.
Mop*	Mop attachment is disconnected. Remove, wipe the connectors and reinsert.

\*Sold separately. Included in accessories bundle.

**Quick Tips:** Clear debris out of nooks and crannies around the brushes and wheels. Use tweezers to remove congestion from the brush ends. Use scissors or cleaning tool to cut hair wrapped around the brushes.



# Accessories

## Wet Mop Attachment\*

**Important Note:** Use distilled water when operating in hard water areas.

1. Place the mopping cloth on the mop attachment.

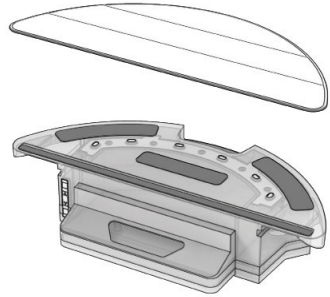

2. Open the tab and fill the reservoir with water.

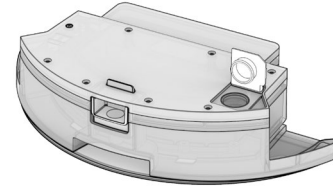

3. Remove the dustbin and insert the mop attachment.

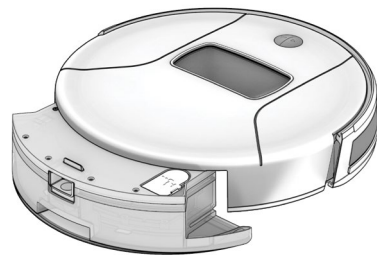

# Accessories

## NoSweep™ Stripes\*

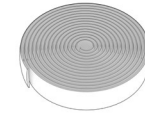

Bob's NoSweep™ stripes allow you to create boundaries Bob will not cross. Place the NoSweep™ stripes on the ground to mark the areas you would like Bob to avoid.

# Maintenance

Part	Maintenance Frequency	Replacement Frequency
Dustbin	Daily	
Filter	Weekly	Every 6 months
Brushes	Weekly	Every 12 months
Sensors	Weekly	
Front Wheel	Weekly	
Battery		Every 12 – 24 months

## Dustbin & Filters

1. Remove the dustbin.

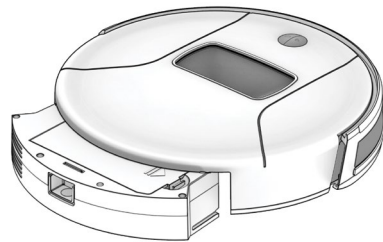

2. Open the dustbin and dump its contents.

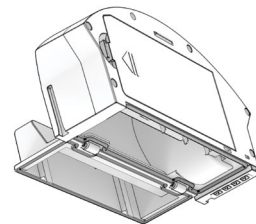

3. Open the filter container and remove congestion.

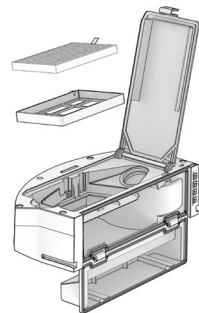

4. Remove and dust the filters. Wipe the dustbin.

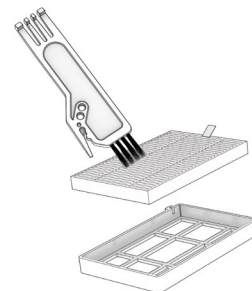

# Maintenance

## Brushes

1. Pull up to remove the side brushes.

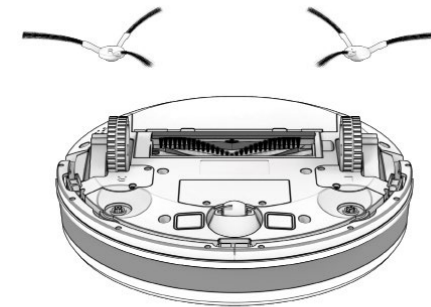

2. Remove debris from the brushes and brush sockets.

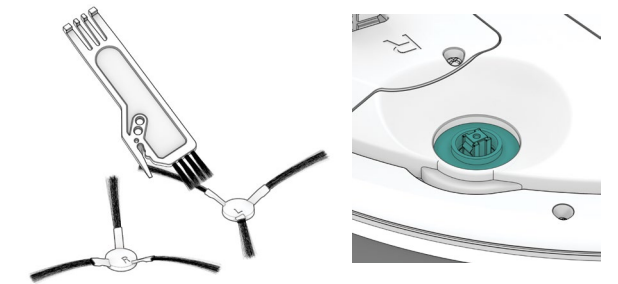

3. Pinch the tabs on the main brush gate and lift.

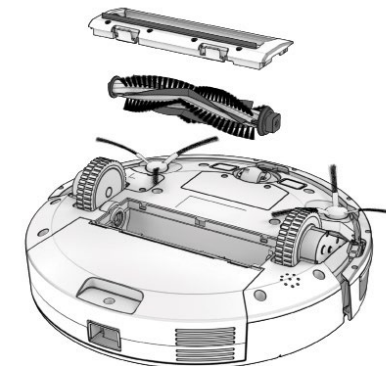

4. Clean the main brush and all its components, including the brush gate and brush compartment.

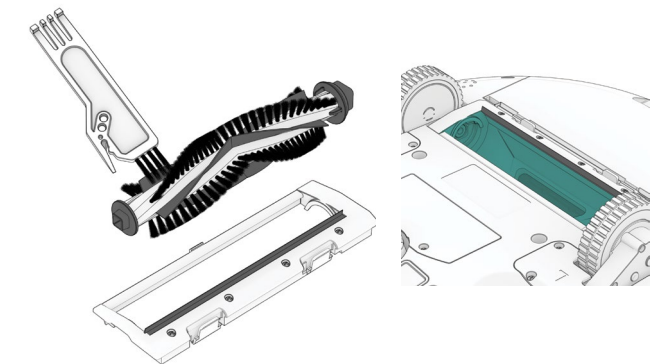

# Maintenance

## Sensors & Camera Window

**Important Note:** Use a cloth to wipe the sensors and camera window.

1. Wipe the edge and wall sensors.

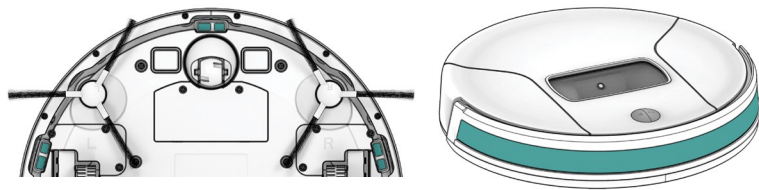

2. Wipe the charging plates on Bob and the charging nodes on his station.

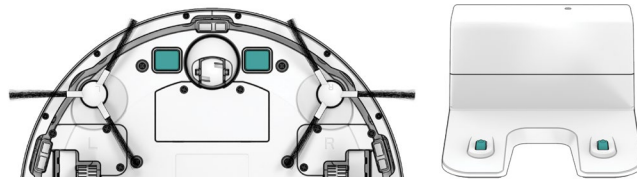

3. Wipe the metal connectors on the dustbin and wet mop attachment.

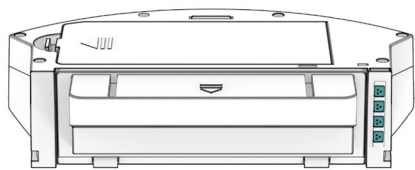

4. Wipe the camera window.



# Maintenance

## Front Wheel

1. Using a flat head screwdriver for leverage, grip the wheel firmly and pull.

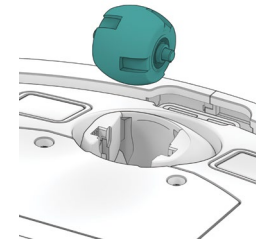

2. Once the wheel is removed, use the screwdriver to pry out the wheel assembly.

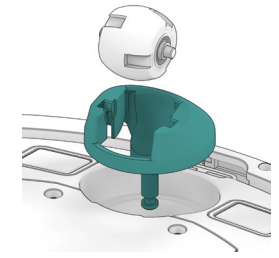

3. Clean the wheel and all its components, including the assembly and wheel socket.

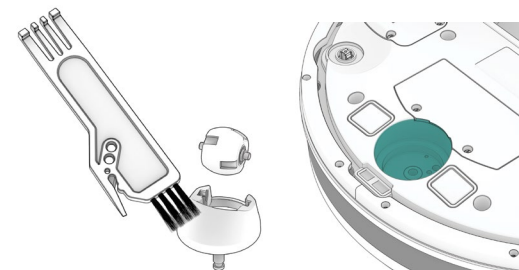

4. Replace both parts when done. Push down to lock them into place.

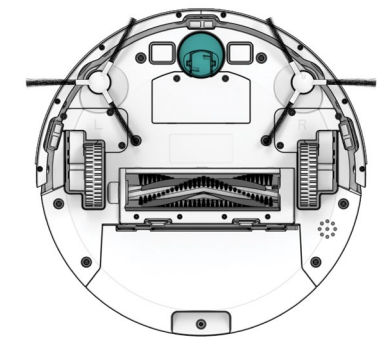

# Maintenance

## Battery

**Important Note:** Power off Bob before replacing the battery. Press and hold the  button.

1. Use a Phillips head screwdriver to open the battery compartment.

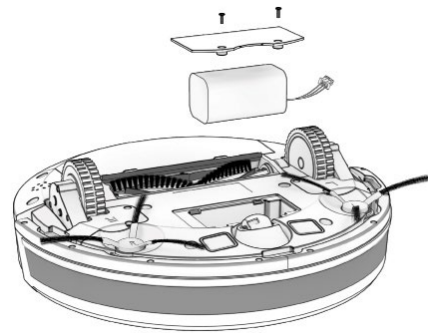

2. Unplug the old battery and plug in your new one.

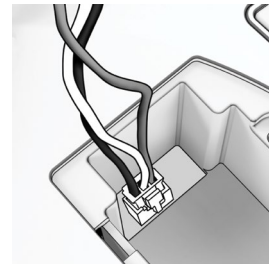

3. Slide the new battery into Bob.

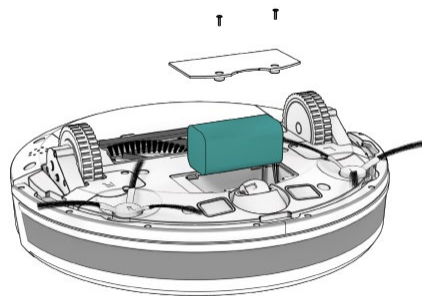

# Maintenance

## Wet Mop Attachment\*

**Important Note:** The reservoir should be drained after use to avoid possible water damage.

1. Remove the mop attachment.

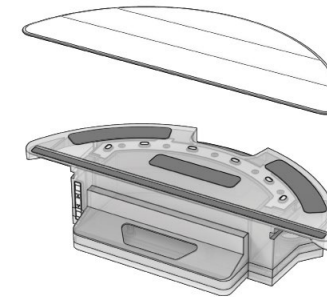

2. Pull open the tab and empty the reservoir.

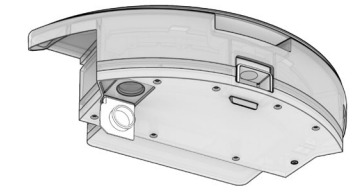

3. Tap any debris that may have collected inside the attachment.

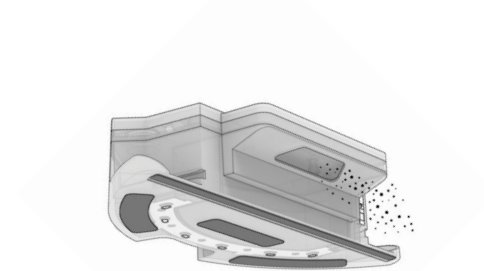

4. Wash the mopping cloth. Air-dry all parts when done.

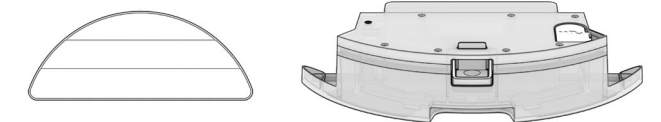

\*Sold separately. Included in accessories bundle.

# End User License Agreement

**IMPORTANT - READ BEFORE USING.** Do not use the robot (“Bobsweep”) accompanying this license agreement (“Agreement”) until you have carefully read and agreed to the following terms and conditions.

By using the Bobsweep, you agree to the terms of this End User License Agreement (“EULA”) and any amendment or addenda accompanying this Agreement. If you do not agree to the terms of this EULA, you may not use the Bobsweep. The Bobsweep contains an electronic and software interface that allows you to control or modify its behavior, and remotely monitor its sensors.

**THIS IS A LEGAL AGREEMENT. BY ACCESSING AND USING THE PRODUCT AND PRODUCT SOFTWARE, YOU ARE ACCEPTING AND AGREEING TO THIS EULA ON BEHALF OF YOURSELF OR THE ENTITY YOU REPRESENT IN CONNECTION WITH THE ACCESS. YOU REPRESENT AND WARRANT THAT YOU HAVE THE RIGHT, AUTHORITY, AND CAPACITY TO ACCEPT AND AGREE TO THIS EULA ON BEHALF OF YOURSELF OR THE ENTITY YOU REPRESENT. YOU REPRESENT THAT YOU ARE OF SUFFICIENT LEGAL AGE IN YOUR JURISDICTION OR RESIDENCE TO USE OR ACCESS THE PRODUCT SOFTWARE AND TO ENTER INTO THIS EULA. IF YOU DO NOT AGREE WITH ANY OF THE PROVISIONS OF THESE TERMS, YOU SHOULD CEASE USING THE PRODUCT AND PRODUCT SOFTWARE.**

## Terms and Conditions

**LICENSE:** Subject to all of the terms of this Agreement, Bobsweep Inc. (“Bobsweep”) grants to you one (1) revocable, royalty-free, personal, non-exclusive, non-transferable, non-assignable, non-commercial intellectual property license to use the Bobsweep software contained on the Bobsweep (“Bobsweep Software”), including the protocol for communicating with the Bobsweep Software, and to use the Bobsweep.

**NONCOMMERCIAL LICENSE:** You may use the Bobsweep Software and the Bobsweep only for personal, non-commercial, educational, and research purposes. The Bobsweep Software and the Bobsweep may not be used for any other purpose, whether “for prot” or “not for prot.” Any work performed or produced using the Bobsweep, including any software that you create for your Bobsweep (“Your Software”), cannot be performed or produced for the benefit of other parties for a fee, compensation, or any other reimbursement or remuneration. A separate license is required for each additional use and/or individual user in all other cases. If you are an entity, Bobsweep grants you the right to designate one individual within your organization to have the sole right to use the Bobsweep Software and the Bobsweep in the manner provided above.

**RESTRICTIONS:** You agree not to: (i) use or copy the Bobsweep Software or the Bobsweep except as provided in this Agreement; (ii) rent or lease the Bobsweep Software or the Bobsweep to any third party; (iii) assign this Agreement or transfer the Bobsweep Software or the Bobsweep except as provided in this Agreement; (iv) modify, adapt, or translate the Bobsweep Software or the Bobsweep in whole or in part except as expressly provided in this Agreement; (v) reverse engineer, reverse compile, or disassemble the Bobsweep Software or the Bobsweep; or (vi) distribute, sublicense or transfer the source code form of Your Software and derivatives thereof to any third party except as provided in this Agreement.

**YOUR SOFTWARE :** Your Software is also subject to the following limitations: You (i) shall be solely responsible for any update or support obligation or other liability which may arise from your use or distribution, (ii) shall not make any statement that Your Software is “certified,” or that its performance is guaranteed, by Bobsweep, (iii) shall not use Bobsweep’s name

or trademarks, (iv) shall prohibit disassembly and reverse engineering of the Bobsweep Software and the Bobsweep, (v) shall not publish reviews of Bobsweep products designated as beta without written permission from Bobsweep, and (vi) shall indemnify, hold harmless, and defend Bobsweep and its suppliers from and against any claims or lawsuits, including attorney’s fees, that arise or result from Your Software, including your use and your distribution.

**TITLE:** Title to the Bobsweep Software remains with Bobsweep or its suppliers. The Bobsweep Software is licensed, not sold. Except as expressly provided herein, Bobsweep does not grant any express or implied right to you under Bobsweep patents, copyrights, trademarks, or trade secret information. You will not remove any copyright or patent notice from the Bobsweep Software or the Bobsweep.

**ONE-TIME TRANSFER:** The initial user of the Bobsweep Software and the Bobsweep may make a one-time permanent transfer of this Agreement, the Bobsweep Software, and the Bobsweep to another end user, provided that the initial user retains no copies of the Bobsweep Software and the Bobsweep. This transfer must include the Bobsweep Software, the Bobsweep, and all of the materials accompanying the Bobsweep (including all component parts and printed materials, any upgrades, and this End User License Agreement document). The transfer may not be an indirect transfer, such as a consignment. Prior to the transfer, the end user receiving the Bobsweep Software and the Bobsweep must agree to all the terms of this Agreement.

**NO WARRANTY AND LIMITED REPLACEMENT: EXCEPT AS STATED IN THE LIMITED WARRANTY TO THE ORIGINAL PURCHASER, THE BOBSWEEP SOFTWARE AND THE BOBSWEEP ARE PROVIDED “AS IS” WITH NO WARRANTIES, EXPRESS OR IMPLIED, INCLUDING BUT NOT LIMITED TO ANY IMPLIED WARRANTY OF MERCHANTABILITY, FITNESS FOR A PARTICULAR PURPOSE, NON-INFRINGEMENT OF INTELLECTUAL PROPERTY RIGHTS, OR ANY WARRANTY OTHERWISE ARISING OUT OF ANY PROPOSAL, SPECIFICATION, OR SAMPLE. NO ORAL OR WRITTEN INFORMATION OR ADVICE GIVEN BY BOBSWEEP OR ITS AGENTS SHALL CREATE A WARRANTY.**

If the Bobsweep Software or the Bobsweep is found to be defective in material or workmanship under normal use for a period of one (1) year from the date of receipt, Bobsweep’s entire liability and your exclusive remedy shall be the replacement of the Bobsweep Software or the Bobsweep. This offer is void if the defect results from accident, abuse, misapplication, or software that you developed for your Bobsweep. Any updates or supplements to the Bobsweep Software or the Bobsweep provided to you after the expiration of the one (1) year period are not covered by any warranty or condition, express, implied or statutory.

**SOME JURISDICTIONS DO NOT ALLOW THE EXCLUSION OF IMPLIED WARRANTIES, SO THE ABOVE EXCLUSION MAY NOT APPLY TO YOU. LIMITATION OF LIABILITY: THE ABOVE REPLACEMENT PROVISION IS THE ONLY WARRANTY OF ANY KIND. BOBSWEEP OFFERS NO OTHER WARRANTY EITHER EXPRESS OR IMPLIED INCLUDING THOSE OF MERCHANTABILITY, NON INFRINGEMENT OF THIRD- PARTY INTELLECTUAL PROPERTY OR FITNESS FOR A PARTICULAR PURPOSE. NEITHER BOBSWEEP NOR ITS SUPPLIERS SHALL BE LIABLE FOR ANY DAMAGES WHATSOEVER (INCLUDING, WITHOUT LIMITATION, VICARIOUS LIABILITY, CONSEQUENTIAL DAMAGES, INCIDENTAL DAMAGES, DAMAGES FOR LOSS OF BUSINESS PROFITS, BUSINESS INTERRUPTION, LOSS OF BUSINESS INFORMATION, OR OTHER LOSS) ARISING OUT OF THE USE OF OR INABILITY TO USE THE BOBSWEEP SOFTWARE, THE BOBSWEEP, OR SOFTWARE THAT YOU DEVELOPED FOR YOUR BOBSWEEP, EVEN IF BOBSWEEP HAS BEEN ADVISED OF THE POSSIBILITY OF SUCH DAMAGES. BECAUSE SOME JURISDICTIONS**

PROHIBIT THE EXCLUSION OR LIMITATION OF LIABILITY FOR CONSEQUENTIAL OR INCIDENTAL DAMAGES, THE ABOVE LIMITATION MAY NOT APPLY TO YOU UNAUTHORIZED USE: THE BOBSWEEP SOFTWARE AND THE BOBSWEEP ARE NOT DESIGNED, INTENDED, OR AUTHORIZED FOR USE IN ANY AERONAUTICAL, NUCLEAR, MEDICAL, LIFE SAVING OR LIFE SUSTAINING SYSTEMS, OR FOR ANY OTHER APPLICATION IN WHICH THE USE OF THE BOBSWEEP SOFTWARE OR THE BOBSWEEP COULD CREATE A SITUATION WHERE PERSONAL INJURY OR DEATH MAY OCCUR.

Should you use the Bobsweep Software or Bobsweep for any such unintended or unauthorized use, you shall indemnify and hold harmless Bobsweep and its officers, subsidiaries and affiliates against all claims, costs, damages, and expenses, and reasonable attorney fees arising out of, directly or indirectly, any claim of product liability, personal injury or death associated with such unintended or unauthorized use, even if such claim alleges that Bobsweep was negligent regarding the design or manufacture of the Bobsweep Software, the Bobsweep, or any part or portion thereof.

USER SUBMISSIONS: You agree that any material, information or other communication, including all data, images, sounds, text, and other things embodied therein, that you transmit or post to a Bobsweep website or provide to Bobsweep (“Communications”) will be considered non-confidential. Bobsweep will have no confidentiality obligations with respect to the Communications. You agree that Bobsweep and its designees will be free to copy, modify, create derivative works, publicly display, disclose, distribute, license and sublicense through multiple tiers of distribution and licensees, incorporate and otherwise use the Communications, including derivative works thereof, for any and all commercial or non-commercial purposes without the payment of any royalty to you, and that such license will survive the termination of this Agreement.

TERMINATION: This Agreement becomes effective on the date you accept this Agreement and will continue until terminated as provided for in this Agreement. You may terminate this Agreement voluntarily at any time. Bobsweep may terminate this Agreement at any time if you are in breach of any of its terms and conditions, and may refuse to license the Bobsweep Software or the Bobsweep to you after termination. Upon termination by either party, you will immediately return to Bobsweep or destroy the Bobsweep Software and the Bobsweep and all your copies thereof. Articles 5 and 7 through 17 of this Agreement shall survive such termination. U.S. GOVERNMENT RESTRICTED RIGHTS: The Bobsweep Software and the Bobsweep are provided with “RESTRICTED RIGHTS.” Use, duplication or disclosure by the Government is subject to restrictions set forth in FAR52.227-14 and DFAR252.227-7013 et seq. or its successor. Use of the Bobsweep Software or the Bobsweep by the Government constitutes acknowledgment of Bobsweep’s rights in them.

NO EXPORT: You may not export the Bobsweep Software or the Bobsweep in violation of applicable export laws.

INTERPRETATION PROVISION: The provisions of this Agreement are severable. If any provision of this Agreement is held to be unenforceable, such provision shall be reformed only to the extent necessary to make it enforceable. Any law or regulation which provides that the language of a contract shall be construed against the drafter shall not apply to this Agreement.

INTEGRATION: This Agreement represents the complete agreement concerning the subject matter hereof, and any and all understandings, conversations and communications, proposals, and counterproposals, oral and written (including any draft of this Agreement) are merged into and superseded by this Agreement and shall be of no force or effect, except as expressly provided herein. No such understandings, conversations, communications, proposals, counterproposals or drafts shall be

referred to in any proceeding concerning this Agreement. Further, no understanding contained in this Agreement shall be modified, altered or amended, except by a writing signed by the party against whom enforcement is sought.

ARBITRATION: All disputes relating to this Agreement (excepting any dispute relating to intellectual property rights) shall be subject to final and binding arbitration, with the losing party paying all costs of arbitration. Any arbitration relating to this Agreement shall be held in California, under the auspices of an arbiter selected by Bobsweep. Any litigation relating to this Agreement shall be subject to exclusive venue and jurisdiction in the federal and state courts of California, with the losing party responsible for costs, including without limitation, court costs and reasonable attorneys fees and expenses.

APPLICABLE LAWS: Any claim arising under or relating to this Agreement shall be governed by the internal substantive laws of the Commonwealth of California, without regard to its principles of conflict of laws. The application of the United Nations Convention on Contracts for the International Sale of Goods is expressly excluded.